

SYSTEMATIC QUALITY

# System and maintenance switches

(Safety switches)



Catalogue



## Safety with electric switches

Pages 3 - 6

Safety with electric switches



Page 3

«Fixed product» systems

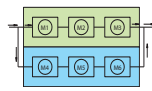

Page 4

Direct and indirect shut-down

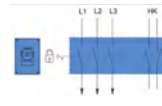

Page 5

Features of GIFAS system and safety switches



Page 6

## Main system switches

## Maintenance switches

Pages 7 - 12

Main system and maintenance switches direct «immediate»



Page 7 - 9

6-pin maintenance inspection switch and 4-pin selector switch



Page 10

Indirect maintenance inspection switch



Pages 11 - 12

## Combinations

Pages 13 - 14

Maintenance and control switch combinations



Page 13

Special combinations



Page 14

## Steel supports

## Snapping-in emergency shut-off switch

## Motor protection switch

Pages 15 - 16

Steel supports/ consoles



Page 15

Snapping-in emergency shut-off switch



Page 16

Motor protection switch

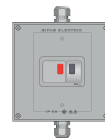

Page 16

## Applications

Pages 17 - 19

Applications



Page 17 - 19

## Basic information

In production and technical operative systems, all measures must be taken to prevent accidents at work in line with art. 82 of the Law on Accident Prevention. This regulation is intended to help prevent accidents at work.

## Safety concept

Very different requirements for the safety concept can arise depending on the operating mode of a system. Safety should be guaranteed both in normal operation and special operating modes. In addition to the safety measures against electrical dangers (due to the flow of electrical energy), measures should also be taken against non-electrical risks (e.g. due to movements).

## Laws, regulations, standards

Detailed information on this subject are given in the following laws, regulations and standards:

- EG-Machines Directive 2006/42/EG, Appendix I, point 1.6.3;
- EN ISO 12100:2010, Safety of machinery, points 6.3.2.4 and 6.3.5.4;
- EN 60204-1:2018, Safety of machinery – Electrical equipment, point 5.4;
- EN ISO 14118:2018, avoiding accidental starts;
- Ordinance on the prevention of accidents and work-related illnesses, SR 832.30, Art. 30;
- SN 411000:2020, Low-voltage installation standard (NIN 2020), points 4.6.4 and 5.3.7.3.2.
- SUVA, the maintenance switch CE93-9.d, 18.5.2020
- EN 62626-1:2014, Low-voltage switchgear and controlgear enclosed equipment
- EN 60947-5-1:2018 Low-voltage switchgear and controlgear, control circuit devices and switching elements
- EN 60947-3:2012 Low-voltage switchgear and controlgear, switches, disconnectors, switch-disconnectors and fuse-combination units



## Correct maintenance – Safe shut-down

Better safe, than sorry. The maintenance engineer is certain that he has definitely shut down the machine. Suddenly it starts up, because...? To avoid this, various regulations and recommendations have been released.

GIFAS-ELECTRIC has tackled this problem and has created a basic range of system and maintenance switches to make your work easier and to keep you safe.



## Integrating the maintenance switch into an overall system (created from functional units)

The system should be divided into groups of functional units for a specific operating purpose.

A technical system or a complex production machine should be divided up into appropriate functional units at the planning stage, and one maintenance switch should be assigned to each unit. This means that operational and safety requirements for the machine are met (e.g. with parallel production lines the option to shut off individual lines without impairing the overall production as otherwise there would be a risk of the maintenance switch not being used). This means that in the event of a fault or a repair, limited production can be maintained on another parallel path, or parts of the system can continue to be operated.

It must be possible to switch off each functional unit using a separate maintenance switch (VUV, Art. 30).

With extensive functional units the maintenance switches must be fitted so that one maintenance switch can be found in the immediate vicinity of every intervention point.

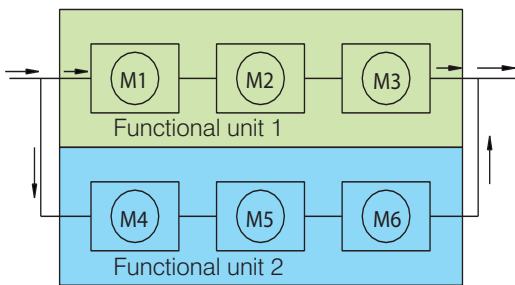

- S1 Main switch/system switch
- S2 Safety switch for functional unit 1
- S3 Safety switch for functional unit 2

## The safety shut-down

Safety shut-down devices must interrupt the flow of power so that no dangerous changes in operating condition can be initiated either through incorrectly entered or faulty control signals.

The safety shut-down device permits persons who need to intervene in the non-electrical danger areas of the system to prevent unintentional changes in the operating status (e.g. initiating a dangerous movement). With simple systems, the system switch can be used to shut down the power supply. However, very often the entire power supply must not be shut down because for example safety devices and control or checking devices must remain in operation, or because with the intervention to be carried out, it must be possible to carry out changes in the operating status intentionally with the special operating control. When designing safety shut-down devices, it is essential to ensure that all power sources are shut off and all stored energy is dissipated that might cause a dangerous change in operating condition. The safety shut-down can carry out the shut-down, depending on the conditions, either directly using a maintenance switch that shuts down all pole lines, or with an indirect shut-down procedure.

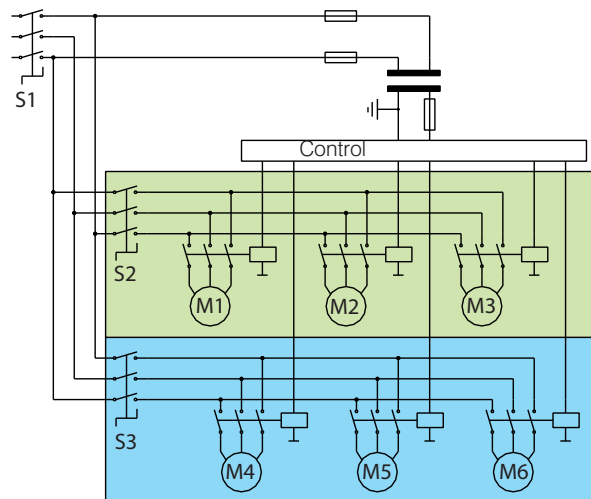

## Direct shut-down (figure 1)

With direct shut-down the supply line to a motor or a system is shut down on all poles directly in the main power circuit. This is achieved with a switch with the two defined positions «0-», which conforms to the requirements for a maintenance switch (see right).

## Indirect shut-down with short-circuit monitoring (figure 2)

With indirect shut-down the main power source is switched via a contactor, for example. The indirect shut-down consists of a maintenance switch (as a control switch) and a safety contactor. The special requirements both for the safety switch and for the safety contactor must be fulfilled.

Safety shut-down devices must have a clearly detectable shut-down which may only be displayed when the power supply has been shut down reliably. When the indirect shut-down device, the actual safety shut-down is carried out via the safety contactor. A feedback lamp fitted directly onto the safety shut-down device actuator must therefore indicate (by lighting up) that the contacts on the safety contactor are actually open.

## The maintenance switch

With an issue date of May 2020, the SUVA/CNA/INSAI permits a revised regulation which describes which basic requirements a maintenance switch must fulfil. In Germany the relevant regulations VDE 01-1996 apply.

## The most important features

### Basic requirements

In technical devices representing a risk in special operating modes (troubleshooting, repairs, maintenance, cleaning, etc.), a maintenance switch must be installed close to each functional unit.

**The maintenance switch must meet the following requirements: It must...**

- have priority over the switching devices in all operating modes,
- interrupt the supply of all dangerous power sources to the system,
- dissipate the dangerous stored power in the system (e.g. vent pneumatics) or store it safely (EN 1037, point 5.3.1.2),
- be labelled (a diagram must be given, for example, showing which area of the system is rendered inactive by the safety switch),
- have a positive effect and have forced opening contacts,
- normally have two switch positions, e.g. «0» (OFF) and «I» (ON),
- be possible to secure it against unintentional and accidental re-actuation in the OFF positions using multiple (at least 3) personal padlocks,
- be easily accessible without causing danger,
- be positioned so that the part of the system shut down can be viewed,
- always be fitted in immediate proximity to the intervention point (in other words, on site),
- with extensive systems or systems distributed across multiple rooms, be fitted at multiple points and wherever interventions are carried out on the system,
- be designed in black or light grey (exception: if the safety switch is also being used as an emergency stop switch, it must have a red handle and a yellow background),
- if the inspection switch also has the «Emergency-Stop» function, no unexpected start-up may be triggered by it being switched on again. This means that switching off the inspection switch must reset the control commands saved by the control system,
- if the return of the power supply after an interruption or after switching on the inspection switch again can lead to a dangerous situation, an unexpected start-up must be prevented. The controller must therefore be informed about the inspection switch being switched off so that saved movement commands are deleted,
- be designed to prevent re-actuation in the shut-down OFF position. This must be observed in particular for the design of the inspection switch with a detachable switch unit.

**With the indirect shut-down, the following conditions must be met:**

- The actual shut-down must be indicated (e.g. using a white indicator light, identified with «0» or «OFF»).
- This display must be safe (e.g. use contactors with forced contacts).
- When the maintenance switch is shut down, it must not be possible to actuate the indirectly actuated switching elements via manual intervention or another outside influence.
- Short circuits in the supply line to the switch must be prevented where mechanical or other hazards exist. This can, for example, be achieved with one of the following measures:
  - Protected routing of the switch supply line (e.g. armoured steel tube),
  - Use of separately routed, shielded lines (shield earthed),
  - Use of cables in which each wire is separately shielded and earthed,
  - Use of a short-circuit monitoring system
- The functioning of the inspection switch must have priority over all other functions. Therefore, the inspection switch must act as closely as possible to the element which disconnects the power, i.e. directly on the contactor coil and not via a bus system or a PLC.

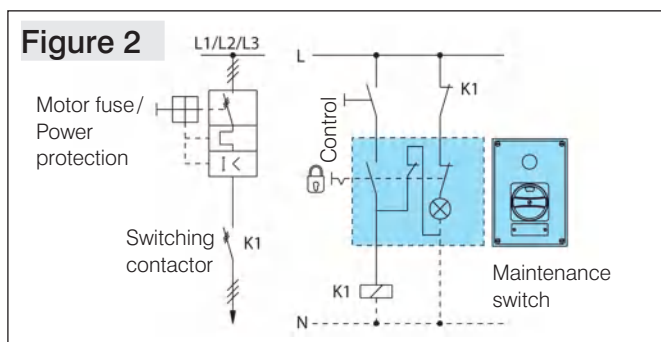
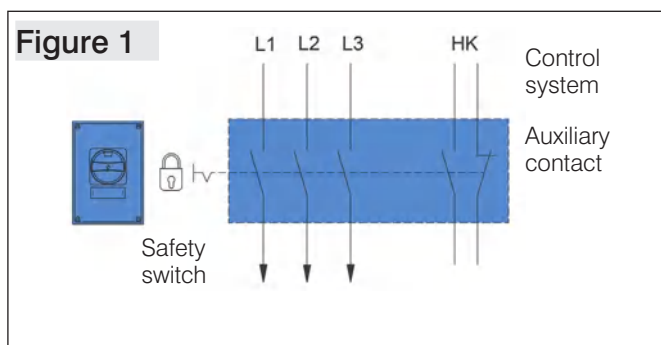

The GIFAS system and safety combinations are designed for systems where mechanical strength, tightness, chemical resistance, sufficient connection space and visual impression are important. Our complete range of hard rubber casings allow us to manufacture customer requirements for on-site combinations flexibly. The most important features of the GIFAS switch combinations are shown on this page.

## Casing specifications

### Material

GIFAS hard rubber casing are made from a special butyl rubber mixture, and the cover from polycarbonate. More information on the casings, such as dimensions, assembly holes, etc., can be found in the brochure «Power distribution boxes», index 1.

### UV resistance

The light grey or black designs as well as the varnished rubber casings are permanently UV-resistant.

### Halogen-free

Completely halogen-free and not contaminated with silicone materials.

### Behaviour in fire

Self-extinguishing.

### Resistance to chemical materials

The hard rubber is in general resistant to alkalis and acids used in industry.

### Resistance to aging

Years of use has not resulted in any problems with aging (becoming hard or brittle, etc).

### Casing materials

In addition to the GIFAS hard rubber casings, switch casings in steel plate, stainless steel A2/A4 and in polyester are also available.

## Switching and display elements

We assemble the products specified by the customer in the relevant designs, outputs and voltages. Our standard products are Sälzer, Kraus & Naimer switches, and main system switches (0-1) also from the manufacturer ABB. As display elements we use Télémécanique (LED).

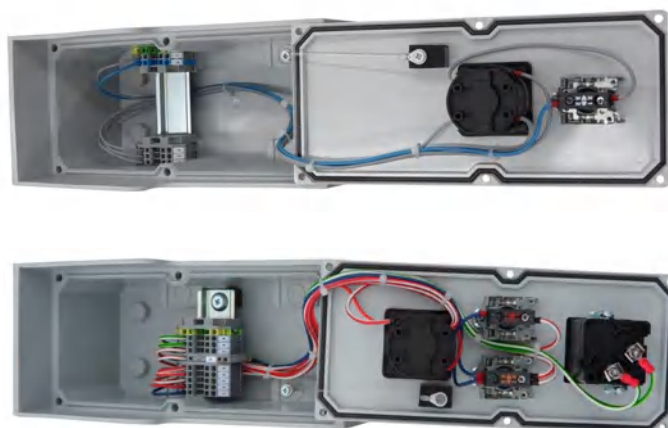

## Terminals

The fitting is carried out according to the diagram with the required terminals, e.g. series or cage tension spring terminals. Our standard products are Wago, Woertz and Phönix terminals.

## Screwed cable glands

High quality screwed cable glands perfect to the finest detail are used and assembled individually according to the diagrams/drawings.

## Assembly fitting types

The screw canals in the casing are outside the sealed area to ensure correct seal and safety insulation. The rapid assembly is made even easier using the rust-free fitting brackets or plates to match the casing.

## Corrosion protection

The cover screws are always made from stainless steel V4A. Assembly accessories such as brackets are made from zinc-plated, A2 or A4 steel, according to the customer's requirements.

## Labelling

With our engraving machine we label the combinations according to your specifications and permanently affix the engraved signs.

## Protection category

Seal groove, sealing part and rubber seal guarantee protection category IP65 on the casing. Depending on the product used with the switch and display elements, the protection categories vary from IP54 to IP65.



# Main system switches and maintenance switches direct «immediate»

Main system switch  
with a red handle on a yellow background

Maintenance switch (safety switch)  
with a black handle on a grey background

IP 65

3-pole and N+PE terminals, Auxiliary contacts 1NC+1NO

Operating power rating for 50-60Hz

IP 65

## Type 1212, 5.5 kW, 125×125×76 mm (L×W×H)



Item no.	Colour
050630	light grey
033302	black

Switch type Sälzer

AC21 400V	AC23 415V	Cable glands
3-16 A	3-16 A	2×M20, 1×M16
3-16 A	3-16 A	2×M20, 1×M16

with auxiliary contact  
1NC+1NO

Item no.	Colour
✓ 050643	light grey
✓ 033320	black

Switch type Sälzer



## Type 1212, 7.5 kW, 125×125×76 mm (L×W×H)

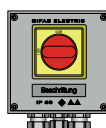

Item no.	Colour
053988	light grey
053615	black

Switch type ABB

AC21 400V	AC23 415V	Cable glands
3-16 A	3-16 A	2×M20, 1×M16
3-16 A	3-16 A	2×M20, 1×M16

with auxiliary contact  
1NC+1NO

Item no.	Colour
✓ 054025	light grey
054024	black

Switch type ABB



## Type 1812, 11 kW, 125×180×90 mm (L×W×H)



Item no.	Colour
050632	light grey
033304	black
050633	light grey
033305	black

Switch type ABB

AC21 400V	AC23 415V	Cable glands
3-40 A	3-23 A	2×M20, 1×M16
3-40 A	3-23 A	2×M20, 1×M16
3-40 A	3-23 A	2×M25, 1×M16
3-40 A	3-23 A	2×M25, 1×M16

with auxiliary contact  
1NC+1NO

Item no.	Colour
050645	light grey
033324	black
050648	light grey
033326	black

Switch type ABB



## Type 1616, 22 kW, 160×160×90 mm (L×W×H)

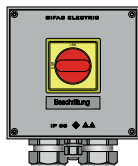

Item no.	Colour
050634	light grey
033308	black

Switch type ABB

AC21 400V	AC23 415V	Cable glands
3-63 A	3-63 A	2×M32, 1×M16
3-63 A	3-63 A	2×M32, 1×M16

with auxiliary contact  
1NC+1NO

Item no.	Colour
050649	light grey
033328	black

Switch type ABB



## Type 2516, 22 kW, 160×250×90 mm (L×W×H)

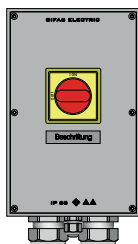

Item no.	Colour
050635	light grey
033310	black

Switch type ABB

AC21 400V	AC23 415V	Cable glands
3-63 A	3-63 A	2×M32, 1×M16
3-63 A	3-63 A	2×M32, 1×M16

with auxiliary contact  
1NC+1NO

Item no.	Colour
050651	light grey
033330	black

Switch type ABB

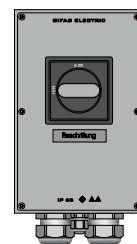

## Type 3020, 45 kW, 200×300×110 mm (L×W×H)

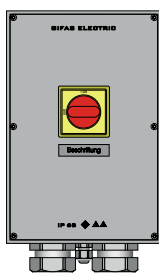

Item no.	Colour
050637	light grey
033315	black

Switch type ABB

AC21 400V	AC23 415V	Cable glands
3-125 A	3-90 A	2×M40, 1×M16
3-125 A	3-90 A	2×M40, 1×M16

with auxiliary contact  
1NC+1NO

Item no.	Colour
050653	light grey
033335	black

Switch type ABB

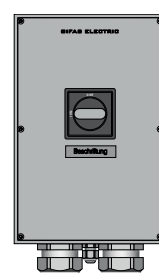

✓ From stock, offer subject to prior sale

Main system switch  
with a red handle on a yellow background

Maintenance switch (safety switch)  
with a black handle on a grey background

IP 65

**3-pole and N+PE terminals, auxiliary contact 1NC+1NO**  
Operating power rating for 50-60Hz

IP 65

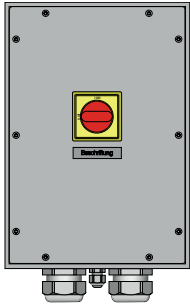

**Type 3800, 45 kW, 250×360×132 mm (L×W×H)**

Item no.	Colour	AC21 400V	AC23 415V	Cable glands
✓ 050638	light grey	3-125 A	3-90 A	2×M40, 1×M16
033316	black	3-125 A	3-90 A	2×M40, 1×M16

Switch type ABB

**with auxiliary contact  
1NC+1NO**

Item no.	Colour
050654	light grey
033336	black

Switch type ABB

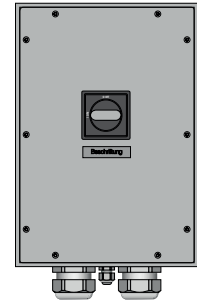

**Type 3800, 75 kW, 250×360×132 mm (L×W×H)**

Item no.	Colour	AC21 400V	AC23 415V	Cable glands
056213	light grey	3-160 A	3-160 A	2×M50, 1×M16
056216	black	3-160 A	3-160 A	2×M50, 1×M16

Switch type ABB

**with auxiliary contact  
1NC+1NO**

Item no.	Colour
058602	light grey
058603	black

Switch type ABB



**Type 7900, 110 kW, 360×500×173 mm (L×W×H)**

Item no.	Colour	AC21 400V	AC23 415V	Cable glands
✓ 145006	light grey	3-200 A	3-200 A	2×M63, 1×M16
145010	black	3-200 A	3-200 A	2×M63, 1×M16

Switch type ABB

**with auxiliary contact  
1NC+1NO**

Item no.	Colour
✓ 145008	light grey
145012	black

Switch type ABB



**Type 7900, 140 kW, 500×360×173 mm (L×W×H)**

Item no.	Colour	AC21 400V	AC23 415V	Cable glands
145019	light grey	3-250 A	3-250 A	2×46-56 mm 1×M16
145021	black	3-250 A	3-250 A	2×46-56 mm 1×M16

Switch type ABB

**with auxiliary contact  
1NC+1NO**

Item no.	Colour
145022	light grey
145023	black

Switch type ABB

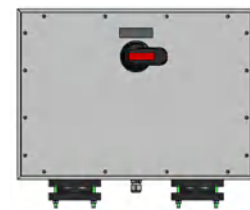

**Surface mounted cabinet A2, 220 kW, 400×600×210 mm (L×W×H)**

Item no.	Colour	AC21 400V	AC23 415V	Cable glands
251488	metallic grey	3-400 A	3-400 A	2×55-65 mm 1×M16

Switch type ABB

**with auxiliary contact  
1NC+1NO**

Item no.	Colour
251489	metallic grey

Switch type ABB



✓ From stock, offer subject to prior sale



# Main system switches and maintenance switches direct «immediate»

Main system switch  
with a red handle on a yellow background

Maintenance switch (safety switch)  
with a black handle on a grey background

IP 65

4-pole and PE terminals, auxiliary contact 1NC+1NO  
Operating power rating for 50 - 60Hz

IP 65



Type 3800, 45 kW, 360×500×173 mm (L×W×H)

Item no.	Colour	AC21 400V	AC23 415V	Cable glands
251491	light grey	4-125A	4-90A	2×M50, 1×M16
with auxiliary contact 1NC+1NO				

Item no.	Colour
251492	light grey
Switch type ABB	



Type 7900, 75 kW, 360×500×173 mm (L×W×H)

Item no.	Colour	AC21 400V	AC23 415V	Cable glands
247504	light grey	4-160A	4-160A	2×M63, 1×M16
with auxiliary contact 1NC+1NO				

Item no.	Colour
226441	light grey
Switch type ABB	



Type 7900, 140 kW, 360×500×173 mm (L×W×H)

Item no.	Colour	AC21 400V	AC23 415V	Cable glands
247505	light grey	4-250A	4-250A	2×46-56mm 1×M16
with auxiliary contact 1NC+1NO				

Item no.	Colour
✓ 245991	light grey
Switch type ABB	



Surface mounted cabinet A2, 220 kW, 400/460×600×210 mm (L×W×H)

Item no.	Colour	AC21 400V	AC23 415V	Cable glands
247508	metal grey	4-400A	4-400A	10×M40 1×M16
with auxiliary contact 1NC+1NO				

Item no.	Colour
245992	metal grey
Switch type ABB	

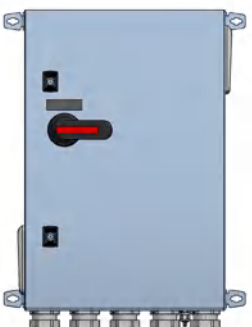

Switching of resistive load,  
+ little overload

Switching inductive loads  
(e.g. motors)

400V	AC21	AC23	kW
OT16	16A	16A	7,5
OT25	25A	20A	9
OT40	40A	23A	11
OT63	63A	63A	22
OT100	100A	80A	37
OT125	125A	90A	45
OT160	160A	160A	75
OT200	200A	200A	110
OT250	250A	250A	140
OT315	315A	315A	160
OT400	400A	400A	220

# 6-pole maintenance inspection switch and 4-pin selector switch

Maintenance inspection switch (safety switch)  
with a black handle on a grey background

6-pole and N+PE terminals, auxiliary contacts 1NC+1NO

IP 65

Operating power rating for 50-v60Hz, AC23, 415V

Selector switch

with a black handle on a grey background

1-0-2 4-pole+N+PE terminals

IP 65



Type 1812, 11 kW, 125×180×90 mm (L×W×H)

Item no.	Colour	AC21 400V	AC23 415V	Cable glands
145384	light grey	6-40A	6-23A	2×M20 1×M16
145385	black	6-40A	6-23A	2×M20 1×M16

with auxiliary contact 1NC+1NO



Type 2516, 7.5 kW, 160×250×90 mm (L×W×H)

Item no.	Colour	AC21 400V	AC23 415V	Cable glands
145646	light grey	4-16A	4-16A	3×M20
145647	black	4-16A	4-16A	3×M20



Type 2516, 11 kW, 160×250×90 mm (L×W×H)

Item no.	Colour	AC21 400V	AC23 415V	Cable glands
145386	light grey	6-40A	6-23A	2×M25 1×M16
145387	black	6-40A	6-23A	2×M25 1×M16

with auxiliary contact 1NC+1NO



Type 2516, 11 kW, 160×250×90 mm (L×W×H)

Item no.	Colour	AC21 400V	AC23 415V	Cable glands
145075	light grey	4-40A	4-23A	3×M20
145076	black	4-40A	4-23A	3×M20

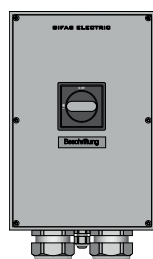

Type 3020, 22 kW, 200×300×110 mm (L×W×H)

Item no.	Colour	AC21 400V	AC23 415V	Cable glands
145453	light grey	6-63A	6-63A	2×M40 1×M16
145456	black	6-63A	6-63A	2×M40 1×M16

with auxiliary contact 1NC+1NO



Type 3020, 22 kW, 200×300×110 mm (L×W×H)

Item no.	Colour	AC21 400V	AC23 415V	Cable glands
145077	light grey	4-63A	4-63A	3×M25
145079	black	4-63A	4-63A	3×M25



Type 3800, 37 kW, 250×360×132 mm (L×W×H)

Item no.	Colour	AC21 400V	AC23 415V	Cable glands
145461	light grey	6-100A	6-80A	2×M50 1×M16
145462	black	6-100A	6-80A	2×M50 1×M16

with auxiliary contact 1NC+1NO

Type 3800, 37 kW, 360×250×132 mm (L×W×H)

Item no.	Colour	AC21 400V	AC23 415V	Cable glands
145080	light grey	4-80A	4-75A	3×M40
145082	black	4-80A	4-75A	3×M40

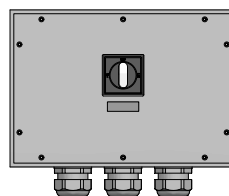

Type 7800, 45 kW, 500×360×132 mm (L×W×H)

Item no.	Colour	AC21 400V	AC23 415V	Cable glands
145463	light grey	6-125A	6-90A	4×M40 1×M16
145466	black	6-125A	6-90A	4×M40 1×M16

with auxiliary contact 1NC+1NO

Type 7800, 45 kW, 500×360×132 mm (L×W×H)

Item no.	Colour	AC21 400V	AC23 415V	Cable glands
145084	light grey	4-125A	4-90A	3×M50
145087	black	4-125A	4-90A	3×M50

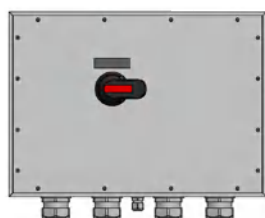

# «Direct» maintenance emergency switches

Indirect maintenance switch in hard rubber housing without protruding protective roof

IP65

## Maintenance switch with locking rim



**Type 1812** 125×180×90 mm

Item no.	LED
✓ 052693	24V
✓ 049164	230V

## Maintenance switch with handle lock

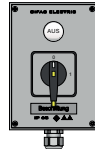

**Type 1812** 125×180×90 mm

Item no.	LED
058605	24V
✓ 058606	230V

## Diagram/text

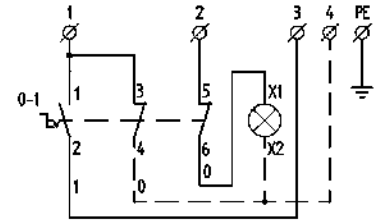

- 1 lockable switch (0-1)
- 1 signal lamp 230V (24V) white terminals 2.5 mm<sup>2</sup> cable gland M20



**Type 1812** 125×180×90 mm

Item no.	LED
029206	24V
029207	230V

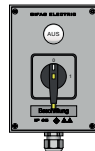

**Type 1812** 125×180×90 mm

Item no.	LED
029208	24V
029209	230V

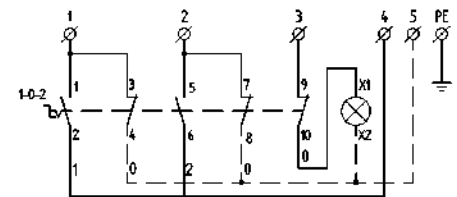

- 1 lockable switch (1-0-2)
- 1 signal lamp 230V (24V) white terminals 2.5 mm<sup>2</sup> cable gland M20



**Type 2516** 160×250×90 mm

Item no.	LED
150843	24V
145541	230V

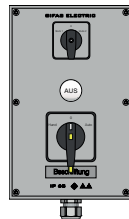

**Type 2516** 160×250×90 mm

Item no.	LED
044841	230V

- 1 switch 1-0-2
- 1 lockable switch 1-0-2
- 1 signal lamp 230V white terminals 2.5 mm<sup>2</sup> cable gland M20

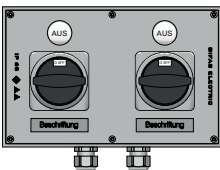

**Type 2516**  
250×160×90 mm

Item no.	LED
145545	230V

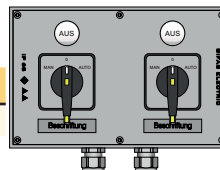

**Type 2516**  
250×160×90 mm

Item no.	LED
145547	230V

- 2 lockable switch 1-0-2
- 2 signal lamp 230V LED white terminals 2.5 mm<sup>2</sup>
- 2 cable glands M20



**Type 3020** 200×300×110 mm

Item no.	LED
145549	230V

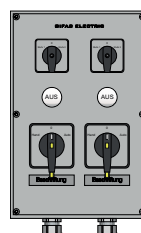

**Type 3020** 200×300×110 mm

Item no.	LED
145550	230V

- 2 switches 1-0-2
- 2 lockable switch 1-0-2
- 2 signal lamp 230V white terminals 2.5 mm<sup>2</sup>
- 2 cable glands M20

✓ From stock, offer subject to prior sale

Indirect maintenance switch in hard rubber housing with protruding protective roof

IP65

## Maintenance switch with locking rim



Type 2812 120×268×132 mm

Item no.	LED
049663	24V
049666	230V



Type 2812 120×268×132 mm

Item no.	LED
049652	24V
049657	230V



Type 2812 120×268×132 mm

Item no.	LED
145623	230V

## Maintenance switch with handle lock



Type 2812 120×268×132 mm

Item no.	LED
058610	24V
058611	230V



Type 2812 120×268×132 mm

Item no.	LED
058612	24V
058616	230V

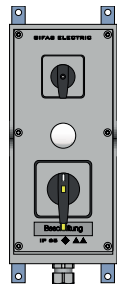

Type 2812 120×268×132 mm

Item no.	LED
145624	230V



Type 7250 160×280×133 mm

Item no.	LED
145626	230V



Type 7250 160×280×133 mm

Item no.	LED
145629	230V



Type 7350 200×350×133 mm

Item no.	LED
145630	230V

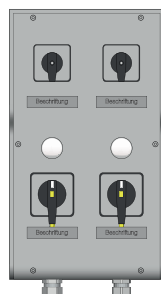

Type 7350 200×350×133 mm

Item no.	LED
145631	230V

## Technical Infos

### Indicator lamp:

24V and 230V LED modules with extremely high service life to 25° 100'000 hours, IP66

### Maintenance switches

with locking rim or handle lock, can be locked using three padlocks

### Switch labels

We mark in accordance with your diagram and have the following marking texts in stock

- MANUAL-O-AUTO
- AUTO-O-MANUAL
- REMOTE-O-ON
- REMOTE-O-LOCAL
- MANUAL-O-REMOTE
- MANUAL-OFF-REMOTE
- ON-OFF-REMOTE
- INSP-OFF-REMOTE

### Terminals

The switch combinations are equipped with WAGO spring-loaded terminals

### Housing colour

Standard light grey RAL 7035, available in black on request.

### Wiring

We supply the on-site combinations on terminals wired or unwired according your diagram.

### Mounting brackets

Material stainless steel V4A



# Maintenance and control switch combinations

Combinations in hard rubber housing with 3-pin maintenance switch, direct switch-off, in combination with a control switch

IP65

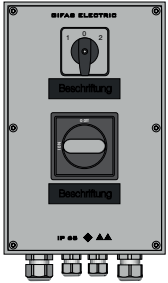

**Type 2516** 160×250×90 mm

Item no.	Equipment
103246	1 Lockable switch 3P-16A 1 Switch 1-0-2 2 Cable glands M20 2 Cable glands M16 Terminals

Combinations in hard rubber housing with maintenance switch, indirect switch-off, control switch and indicator lamps

IP65

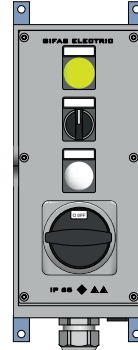

**Type 2812** 120×268×132 mm

Item no.	Equipment
145732	1 Lockable switch 0-1 1 Switch 1-0-2 1 Signal lamp LED 24V white 1 Signal lamp LED 24V yellow 1 Cable gland M25 Terminals

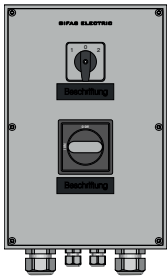

**Type 3020** 200×300×110 mm

Item no.	Equipment
103248	1 Lockable switch 3P-25A 1 Switch 1-0-2 2 Cable glands M25 2 Cable glands M16 Terminals



**Type 2516** 160×250×90 mm

Item no.	Equipment
132103	1 Lockable switch 0-1 1 Switch 1-0-2 1 Illuminated push-button green 230V 1 Illuminated push-button red 230V 1 Signal lamp LED white 230V 2 Cable glands M20 Terminals

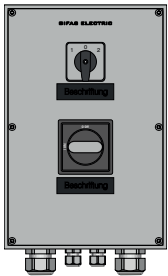

**Type 3020** 200×300×110 mm

Item no.	Equipment
145673	1 Lockable switch 3P-32A 1 Switch 1-0-2 2 Cable glands M25 2 Cable glands M16 Terminals

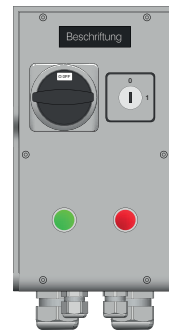

**Type 7250** 160×280×133 mm

Item no.	Equipment
050669	1 Lockable switch 3P-32A+HK 1S 1 Key switch 0-1 KABA 1 Pushbutton green 1 Pushbutton red 2 Cable glands M32 2 Cable glands M20 Terminals

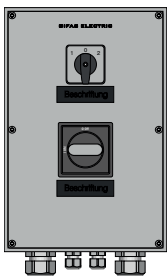

**Type 3020** 200×300×110 mm

Item no.	Equipment
103249	1 Lockable switch 3P-45A 1 Switch 1-0-2 2 Cable glands M32 2 Cable glands M16 Terminals

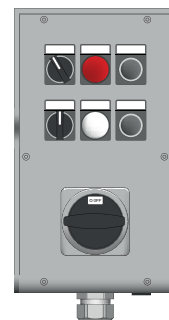

**Type 7250** 160×280×133 mm

Item no.	Equipment
142844	1 Lockable switch 0-1 1 Switch 1-0-2 1 Switch 0-1 2 Pushbuttons black 1 Signal lamp LED white 24V 1 Signal lamp red 24V 1 Cable gland M25 Terminals

# Combinations of multiple maintenance switches, Special combinations

Combinations in hard rubber housing with several maintenance switches, indirect switch-off, control switch and indicator lamps

IP65

Combinations in hard rubber housing with several maintenance switches, indirect switch-off, control switch, indicator lamps and socket outlets

IP44

Type 7450 266×370×133 mm

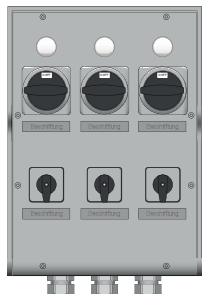

Item no.	Equipment
058640	3 Lockable switch 1-0-2
	3 Signal lamps LED white 230 V
	3 Switch 1-0-2
	3 Cable glands M25 Terminals

Type 7450 266×370×133 mm

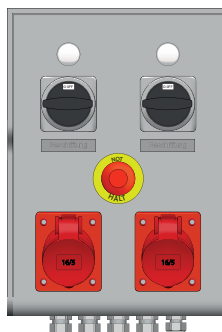

Item no.	Equipment
050710	2 Lockable switch 1-0-2
	2 Signal lamps LED white 230 V
	1 Snapping-in emergency shut-off switch
	2 Built-in socket CEE 16A 400V
	1 Cable gland M16
	4 Cable glands M20 Terminals

Type 7750 336×370×162 mm

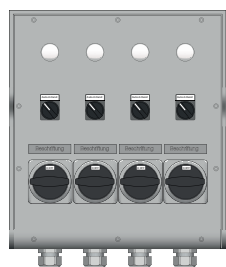

Item no.	Equipment
058645	4 Lockable switch «1-0-2»
	4 Switch 1-0-2
	4 Signal lamp LED white 24 V
	4 Cable glands M25 Terminals

Type 7750 336×370×162 mm

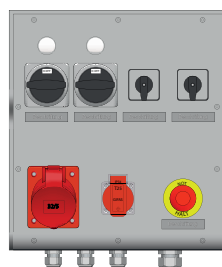

Item no.	Equipment
050711	2 Lockable switch 0-I
	1 Switch «0-I»
	1 Switch «0-1-2-3»
	2 Signal lamp LED white 230V
	1 Snapping-in emergency shut-off switch
	1 Built-in socket Typ 25
	1 Built-in socket CEE 32 400V
	3 Cable glands M20
	1 Cable gland M25 Terminals

Type 7800 500×360×133 mm

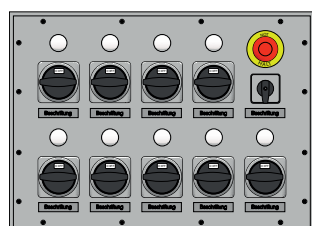

Item no.	Equipment
145274	9 Lockable switch 1-0-2
	9 Signal lamp LED white 230 V
	1 Switch 1-0-2
	1 snapping-in emergency shut-off switch without cable gland



Type 7400 / 7450 532×370×133 mm

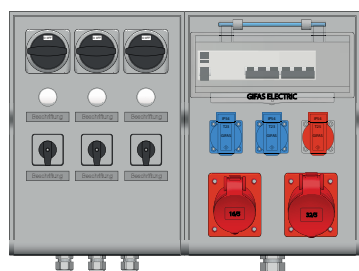

Item no.	Equipment
058639	3 Lockable switch 0-1
	3 Signal lamp LED white 230 V
	3 Switch 1-0-2
	2 Built-in sockets Type 23
	1 Built-in sockets Type 25
	1 Built-in sockets CEE - 16A
	1 Built-in sockets CEE - 32A
	1 Switch FI 3N 40A 30mA
	1 Circuit breaker 3P 13A
	1 Circuit breaker 3P 16A
	3 Cable glands M20
	1 Cable gland M25



With steel supports or consoles in different designs, the on-site combinations can be installed at the correct location as well as being protected against mechanical damage and the effects of the weather. **The steel constructions are powder-coated, zinc-plated or manufactured from rust-free material in V2A or V4A.** In collaboration with experienced technicians and metal engineers we develop the right design for you, tailored to fit the various hard rubber casings.

## Example specifications:

Steel console type **KA** (GIFAS-ELECTRIC), **V2A glass-blasted**, to fit on-site combination type **7350**, overall height **1'400 mm**.

Type GE

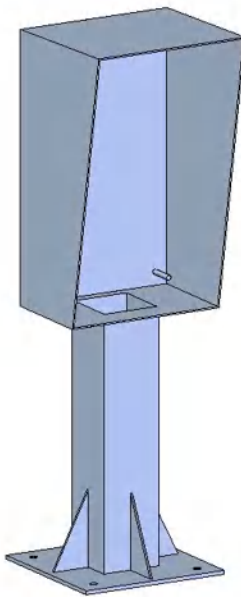

Type DE

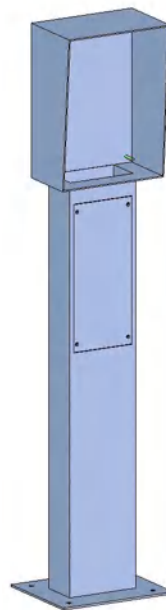

Type KA

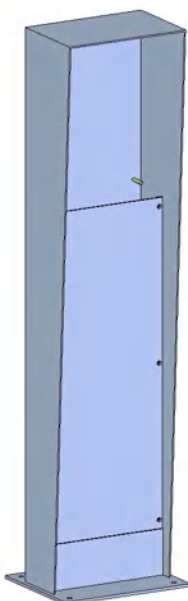

Type APFE

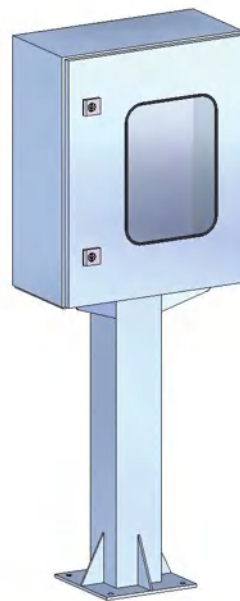

## Emergency-Stop / Emergency-Off button

Emergency-Stop / Emergency-Off button, tamper-proof, with mechanical detent in hard rubber housing

IP55

Type 1010 100×100×65 mm

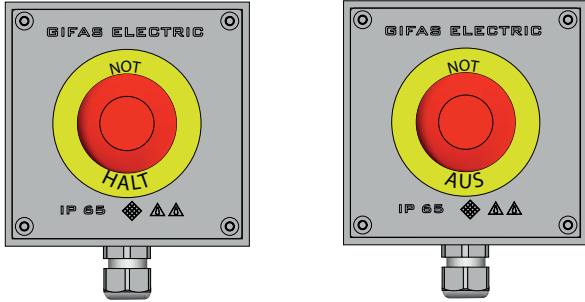

In case of an Emergency Off, the system must be deenergised immediately.

In case of an Emergency Stop, a movement must be stopped as quickly as possible (part of system).

## Motor protection switch with thermal-magnetic tripping

Rated output of three phase current motors 50/60Hz according to usage categories AC-3, in solid rubber enclosure

IP55

Type 1616 160×160×90 mm

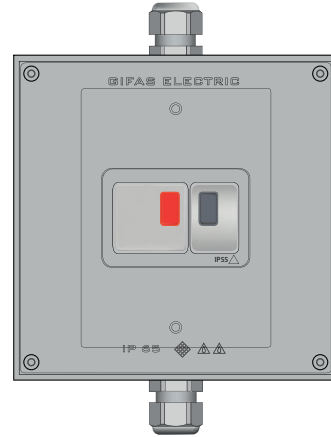

## Emergency-Stop / Emergency-Off button

Emergency-Stop	Emergency-Off button				
Item no.	Item no.	Colour	Release Function	Auxiliary switch	
050729	146593	light grey	pull release	1NC	1NO
030130	146594	black	pull release	1NC	1NO
050731	146595	light grey	twist-release	1NC	1NO
030136	146597	black	twist-release	1NC	1NO
146545	146598	light grey	twist-release		2NO
146547	146599	black	twist-release		2NO
146546	146600	light grey	twist-release	1NC	2NO
146548	146601	black	twist-release	1NC	2NO
146549	146602	light grey	key-release	1NC	1NO
036735	146604	black	key-release	1NC	1NO

Item no.	Colour	400V / kW	Setting range of therm. activation	Activation current
146490	light grey	0.25-0.37	0.63 - 1.00A	13A
146491	light grey	0.37-0.55	1.00 - 1.60A	22A
146492	light grey	0.75	1.60 - 2.50A	33A
146493	light grey	1.10-1.50	2.50 - 4.00A	51A
146494	light grey	2.2	4.00 - 6.30A	78A
146495	light grey	3.00-4.00	6.00 - 10.0A	138A
146496	light grey	5.5	9.00 - 14.0A	170A

Cable glands 2×M20

### Additional modules

Item no.	Description
049710	Auxiliary switch, no delay, side 1NC+1NO
049711	Locking device for padlocks in «O» switch position

The mushroom push-button and Emergency-Stop / Emergency-Off button with a tamper-proof design and with a mechanical detent comply with standard EN/IEC 60204-1.

- Button diameter: standard 40 mm red
- Emergency-Stop / Emergency-Off sign: diameter 60 mm yellow
- Key-release : Supplied with 2 keys
- Control devices: in metal design











GET IN TOUCH WITH US

News about the assortment and specific solutions can be found on our website:

[www.gifas.ch](http://www.gifas.ch)

We reserve the right to make technical modifications. V 0224



**GIFAS**  
ELECTRIC

**GIFAS-ELECTRIC GmbH**  
Dietrichstrasse 2  
CH-9424 Rheineck

+41 71 886 44 44  
+41 71 886 44 49  
info@gifas.ch  
www.gifas.ch