

SYSTEMATIC QUALITY

Fire resistant junction boxes

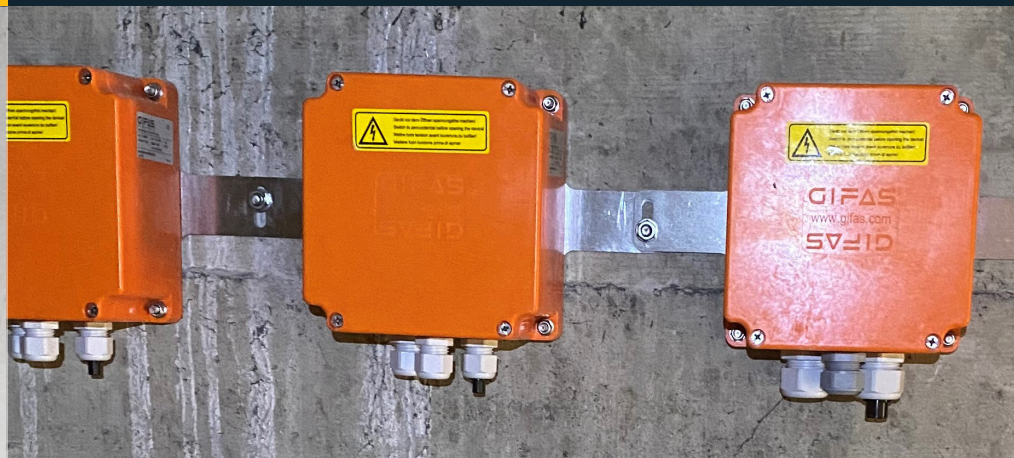

Catalogue



GIFAS
ELECTRIC

04A

Introduction/ Information

Pages 3-6

Webshop



Page 3

Fire resistant
Junction box



Page 4

Laws/Stand-
ards/Directives



Page 5

Difference of fire resistant
and conventional junction
and distribution boxes



Page 6

Polyester junction and distribution boxes GRP

Type 1616

Type 2516

Type 3018

Pages 7-8

Type 1616



Page 7

Type 2516



Page 8

Type 3018



Page 8

Accessories mounting plates and brackets

Page 9

Accessories



Page 9

DECONTACTOR™ DS F400 HT 3625

Page 10-11

DECONTACTOR™
DS F400



Page 10

HT 3625



Page 11

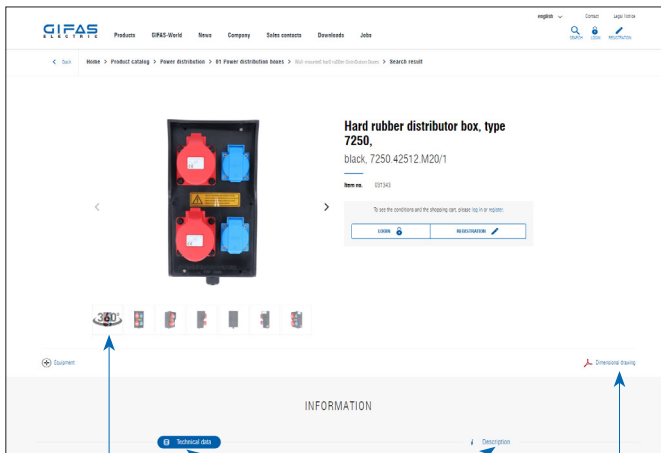

360° images

Technical data/Description

Technical drawing/
information



The GIFAS website offers an extensive assortment for customers from trade and industry. The simple and customer-friendly interface quickly takes you to the desired product. Take the plunge and have direct access to more than 3'000 articles.

► Go to the website: www.gifas.ch

Your benefits

- download CAD drawings, electrical diagrams and other product information
- customised solutions
- practical examples
- product documentation

GIFAS-World

We will guide you through the GIFAS World on our website with animated situations at the workplace and at home. Our advanced product solutions are used in the most diverse areas - roads, railways, hospitals, sewage plants or wherever electricity, light and safety are required. The areas of application are numerous and varied. Let us inspire you! Click on www.gifas.ch/world and immerse yourself in the all-embracing landscape of the GIFAS World.



Safety has priority

Modern building architecture places enormous requirements on the reliability of the electrical systems. This applies especially in the case of fire. Here, GIFAS products for electrical functional integrity fulfil a demanding task. They ensure that safety-related systems remain available if there's a fire. Cable junction boxes, connection boxes and small-scale distributors from GIFAS are part of the safety concept of buildings all over the world. They protect the sensitive electronics against fire, heat, smoke and moisture. Tested, proven, reliable.

Security of a strong brand

Trademark counterfeiting is becoming an increasing problem in the electrical industry. Counterfeiters flood the market with products that look just like the original brands – with fatal consequences for fire protection. Only a quality electrical product guarantees a defined period of time in which the current continues to flow – valuable minutes that can be essential for rescuing fleeing people, for instance.

Higher material quality, improved combustion behaviour and comprehensively tested properties permit this time saving. To ensure the safety that is absolutely essential here, GIFAS decided upon the range of products and reliability of the industry leader, Spelsberg. As a brand name manufacturer, Spelsberg provides safety: With significant investments in research and technologies, with stringent national and international test procedures and with the reputation of a proven brand name.

Electrical functional integrity

Functional integrity of the electrical systems is when the safety-relevant current continues to flow and there is no short circuit during a fire. As a result, the power supply of the escape and rescue routes should remain intact if exposed to fire from outside. Electrical functional integrity is important at all locations where there are large numbers of people, such as schools, hospitals, public authorities, industrial facilities or shopping centres. Because fires can never be entirely excluded despite the greatest safety precautions, the requirements on material and installation cannot be great enough. The program from GIFAS offers planners, operating companies and installation engineers optimum quality where vitally important functional integrity is concerned.

DIN 4102 part 12

To ensure no one is hurt by fire and smoke, the fire regulations of electrical installations are rigorously imposed for the constructional and electro-technical fields. The functional integrity of electrical cable systems in accordance with DIN 4102 part 12 is of particular importance.

This standard stipulates that only complete cable systems including all components, such as the installation system, cables and wall plugs, can be checked for their functional integrity and approved.

Spelsberg is the connecting element here. All fire protection-products offer demonstrable functional integrity in classes E30 to E90 – for the highest requirements in housing construction and administrative buildings up to large-scale projects for the industrial and transport sectors.

Valuable minutes: E30 to E90

E30

Guarantee of the electrical functional integrity for at least 30 minutes

- Fire alarm systems
- Acoustic systems
- Emergency lighting
- Lifts with evacuation circuit

E60

Guarantee of the electrical functional integrity for at least 60 minutes

- Depending on the use of the building and fire protection concept, functional integrity of E60 is also specified for the emergency power supply.

E90

Guarantee of the electrical functional integrity for at least 90 minutes

- Pressure boosting stations for fire extinguishing water
- Smoke and heat exhaust ventilation systems
- Firefighter lifts
- Emergency power supply

Comprehensive protection: Demonstrable

GIFAS supports users with in-depth expertise and comprehensive test certificates, from Spelsberg of course. The products from the fire protection programme are checked electrically by the German Association for Electrical, Electronic & Information Technologies (VDE) and in terms of fire protection by the material testing institutions. In addition, they undergo the electrical tests in accordance with the national and international standards. Used together with appropriately approved cables and installation systems, they offer electrical functional integrity in classes E30 to E90 in accordance with DIN 4102 part 12.



Legal basis for electrical functional integrity / Regulations that save lives

When there is a fire in a public building, the main electrical systems must remain in operation: This includes the lighting system of the escape and rescue routes in the same way as lifts or smoke and heat exhaust ventilation systems.

The functioning of the systems in the initial phase of a fire can be the difference between life and death. Strict statutory conditions for fire protection in buildings are therefore intended to protect people, animals and material assets. The legal requirements from two areas should be noted for the erection of electrical systems: the building codes and the electrical rules and regulations.

What is especially relevant for fire protection and electrical functional integrity can be summarised from the different laws and regulations.

General requirements

Systems must be **arranged**, **erected**, modified and **maintained** in such a way as not to endanger public safety and order, with particular regard to human life, health and natural resources.

Fire protection

Building systems must be **arranged**, **erected**, modified and **maintained** in such a way that the occurrence of fire and the spread of fire and smoke (fire propagation) is prevented and that the rescue of people and animals as well as effective fire-fighting operations are possible if there is a fire.

- Arrangement** = planning of the architects/specialist planners
- Erection** = execution of the works by tradesmen and construction firms
- Maintenance** = ongoing maintenance by the building owners or operators

Definition: Wiring systems

are systems made up of cables, especially of electrical lines or pipelines, as well as the associated fittings, house connection equipment, measurement equipment, control, regulation and safety devices, mains units, distributors and insulating materials for the cables. The cables include their mountings and coatings. Fibre optic cables and electrical cables are considered to be electrical wiring.

Definition: Cabling systems

In the electrical rules and regulations of the VDE, cabling systems are defined as follows under DIN VDE 0100-200 in the main section 826-15: 826-15-01 Cabling systems Assembly made up of one or more insulated conductors, cables or busbars and the parts which secure their fixing and, if necessary, their mechanical protection.

Accessible cable ducts, cable conduits and cable racks are also defined in this section.

DIN 4102

According to relevant implementation of laws and regulations, the cables, junction boxes and distributors must be tested for the electrical functional integrity in accordance with DIN 4102 in particular. The testing details for the fire behaviour of building materials and building components are set out there. Walls, ceilings or stairways, for example, but also cable insulation or installation shafts and ducts as well as electrical cables are considered as building materials or building components. According to DIN 4102, all electrical cables and elements are tested in different fire resistance classes.

Part 12 of the DIN 4102 lays down the regulations for the functional integrity of electrical cables. The functional integrity can be certified in classes E30, E60 and E90. That means the electrical systems continue to function for 30, 60 or 90 minutes in case of fire.

On the other hand, distribution boxes are tested as space-enclosing components according to part 2 of DIN 4102. Here, a fire resistance (F) of the external walls of the distributor must be demonstrated for a time period of 30, 90 or 120 minutes.

VDE standards for boxes and distributors

DIN EN 60670 (VDE 0606) stipulates the general requirements for boxes and enclosures for household and similar fixed electrical installations. The regulations to which all boxes must correspond for protection against electric shock, protective conductor connections, insulation resistance and high voltage, heat resistance and the resistance of insulation materials to excessive heat and fire, for example, are defined here.

There is also an appropriate test standard for distributors. This is because the many different properties of the individual components must be coordinated in order to function safely – the technical details to be taken into account are described by the standard DIN EN 61439-1 for «Low-voltage switchgear and control gear assemblies; part 1: Type-tested and partially type-tested assemblies».

Insulation integrity

Besides the testing of electrical functional integrity, the testing of their insulation integrity during exposure to flames in accordance with DIN VDE 0472 is also relevant for many electrical installation products for safety in the event of fire.

While complete cable systems are tested in test furnaces at high temperatures (starting from room temperature up to 1'000°C after 90 min.) with electrical functional integrity, but not in direct fire, the testing for insulation integrity involves the direct flame treatment of a cable with a length of 50 cm at 750°C. If, after the test period – normally 180 min., current is still flowing and neither a short-circuit nor any open-circuit has occurred, the test is considered as passed. The cable is given the classification FE 180. FE stands for the effects of flames or fire.

Functionality and insulation integrity

«Why do I need both tests?» some people may ask. In both tests cables are tested with energy applied at extremely high temperatures. But fires have very different characteristics. Hence, a fire can occur in the direct vicinity of a cable installation. Within the shortest time, the flames reach the cables and they must withstand the direct fire.

In other cases, a fire may possibly develop in the adjacent area. The further the fire spreads, the more the adjacent areas heat up. After some time, where the temperature was just 20°C shortly beforehand, more than 1'000°C prevail without flames reaching the cable installation directly.

The aim in both cases is that the products can continue to carry current under these extreme conditions. Both tests provide safety – on the one hand, they test the heat resistance of the material and, on the other hand, they guarantee insulation against direct flames. Only one product – that bears both the marking E30, E60, E90 as well as the marking FE 30, 90, 180 – offers full fire protection.

Legislation in Switzerland

Switzerland has the same requirements as Germany and the EU, see VKF AEAL fire protection directive from 01.01.2015 17-15 Marking of escape routes Safety lighting was just 20°C shortly beforehand, more than 1'000°C prevail without flames reaching the cable installation directly. Emergency power supply 01.01.2015 / 1-15 Fire protection standard.

Type 1616



Type 2516



Type 3018

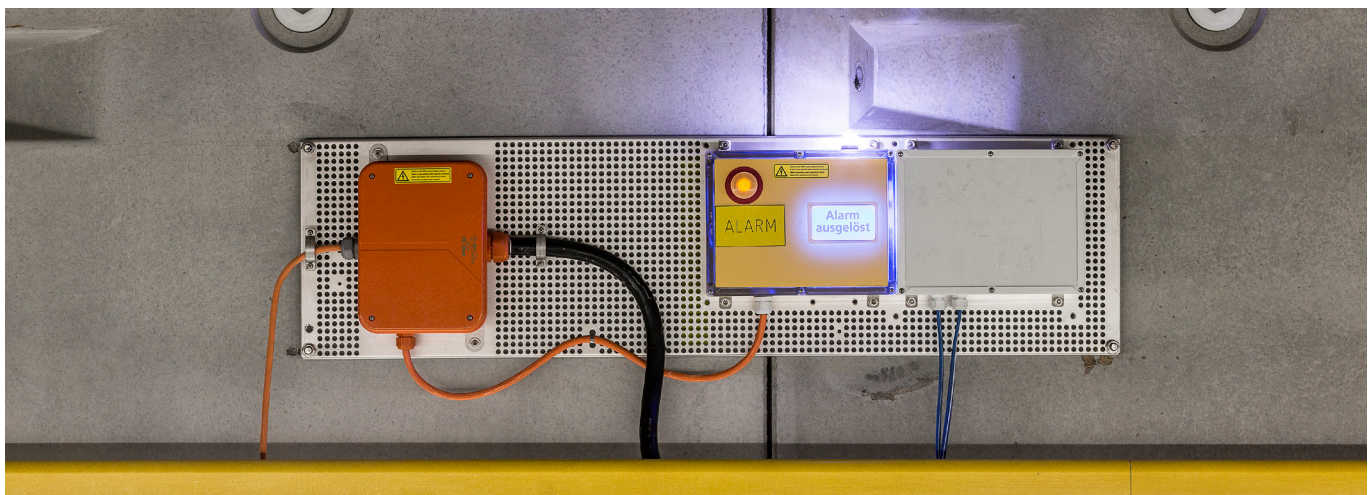
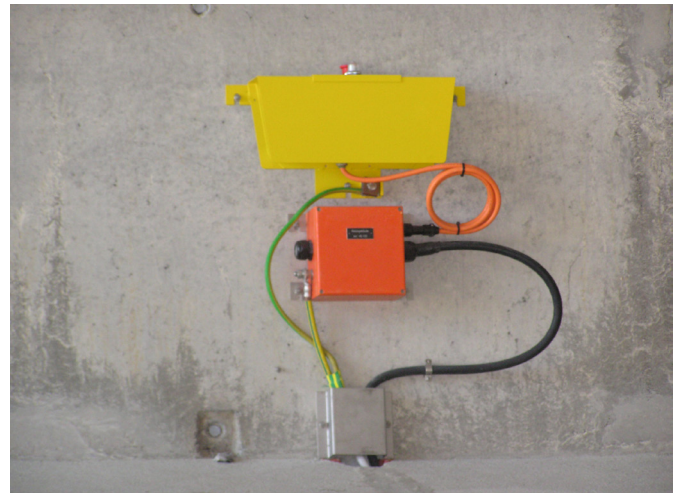

Polyester junction and distribution boxes GRP type 1616

Glass fibre reinforced polyester junction and distribution boxes fireproof

Due to many customer requests we have extended our product range in collaboration with external specialists. We proudly present you our fire-proof fiberglass reinforced polyester junction boxes, which correspond to highest standards.

Besides our approved hard rubber product range we are now able to fulfill highest chemical and mechanical demands, especially for such systems as in tunnels, in civil engineering, and in chemical and petrochemical industry.

Junction boxes ORANGE, E30

Design approved to IP66/68

Along to Test Report APM Technica: APM_BE_3301389 water and dust in accordance with DIN EN 60529:2014

Functional integrity E30 based on DIN 4102 part 12 E30

According to report MPA-Dresen 20190264 in accordance with DIN EN 1363-1; 2012-10

As a result of the higher protection category and the certification according to DIN 4102 Part, the boxes are ideal for adaptive, lane and safety lighting, especially in the national road network and tunnels - individual equipment to customer requirements possible!

Special features

- safety insulated
- impact-resistant
- UV resistant - halogen free
- resistant to aging and temperature resistant
- resistant to oil and acid
- widely resistant to chemicals
- flame retardant, self-extinguishing
- non-flammable
- with 4 exterior assembly and fixing points
- max. equipment: screw terminals up to 35 mm²
- audited functional integrity of at least 30 minutes at temperatures up to 900°C

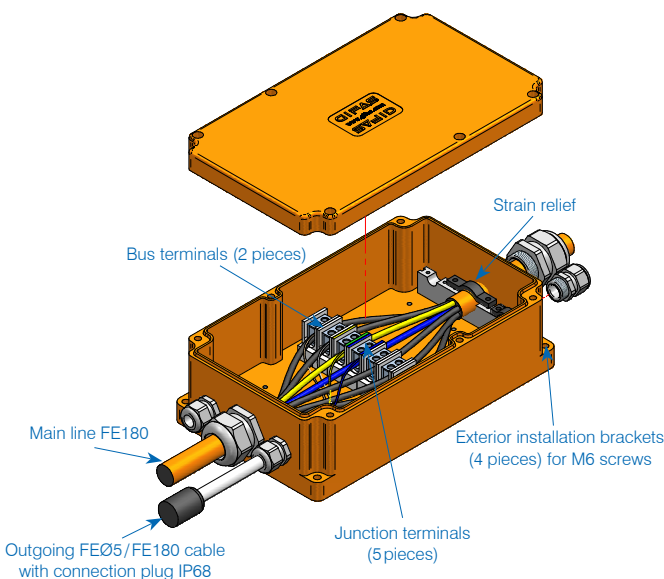
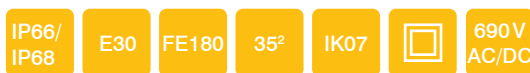

Technical Data E30

Specification box type 1616 FE180/E30

- junction box polyester enhanced glass fiber reinforced
- colour: orange RAL 2009
- protection category: IP68
- W×H×P: 160×160×100 mm



BFA 1616 – 160×160×100 mm/5×16 mm²
Item no.: 205667

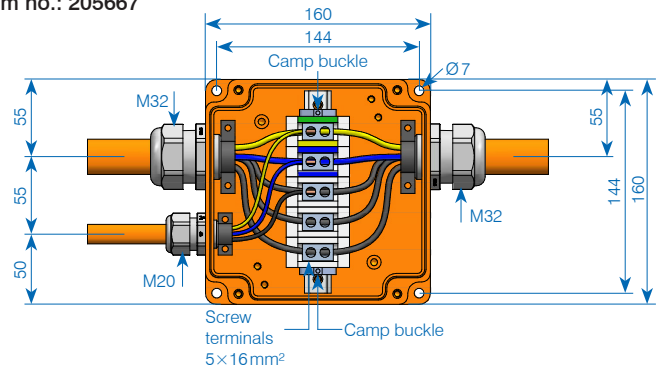

BFA 1616 – 160×160×100 mm/7×6 mm²
Item no.: 205668

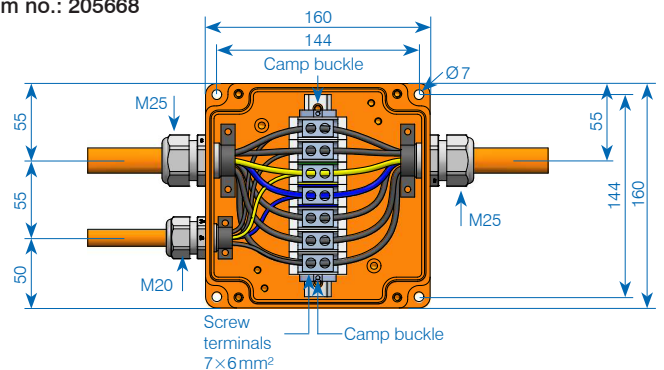

Technical Data E30

Specification box type 2516 FE180/E30

- junction box polyester enhanced glass fiber reinforced
- colour: orange RAL 2009
- protection category: IP66
- W×H×P: 250×160×100 mm



BFA 2516 – 250×160×100 mm / 5×16 mm²
Item no.: 205665

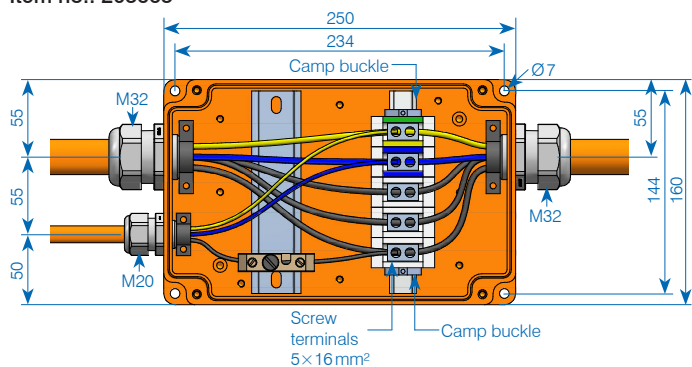

Technical Data E30

Specification box type 3018 FE180/E30

- junction box polyester enhanced glass fiber reinforced
- colour: orange RAL 2009
- protection category: IP66
- W×H×P: 300×180×100 mm



BFA 3018 – 300×180×100 mm / 5×35 mm²
Item no.: 189886

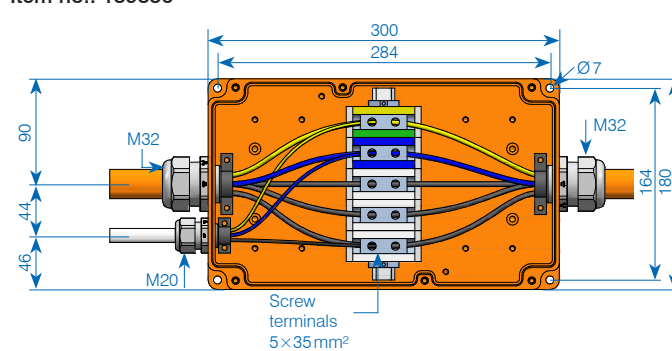

BFA 2516 – 250×160×100 mm / 8×16 mm²
Item no.: 205666

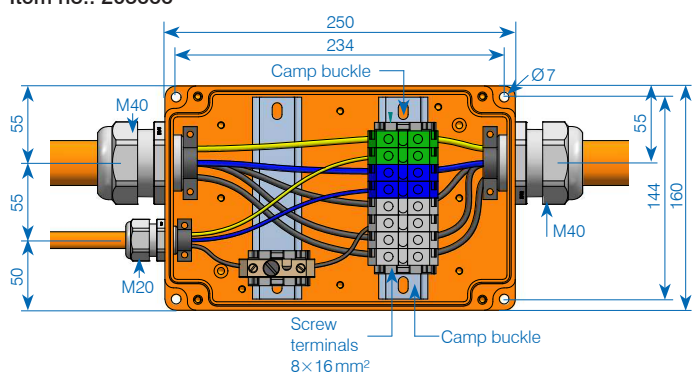

BFA 3018 – 300×180×100 mm / 7×10 mm²
Item no.: 189887

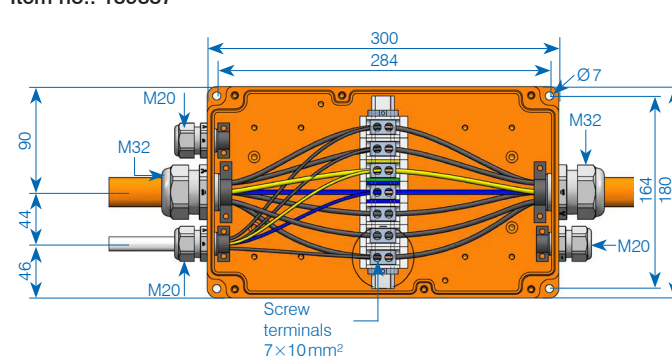

BFA 3018 – 300×180×100 mm / 7×10 mm²
Item no.: 189888

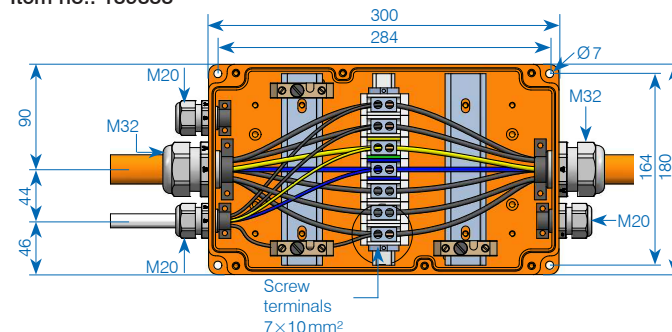

Accessories: mounting plates and brackets

Mounting plates and brackets

A large number of different mounting plates and brackets are available for quick and easy installation of the junction boxes on ducts, tunnel ceilings or mounting supports. It goes without saying that individual special solutions are possible.

Material in V4A stainless steel 14571 or as according to customer requirements.

Mounting plate, crosswise, V4A stainless steel for type 1616 boxes Item no.: 207053

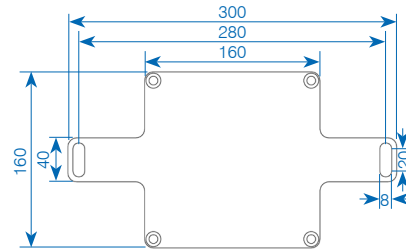

Mounting plate, crosswise, V4A stainless steel for boxes type 2516 Item no.: 207052

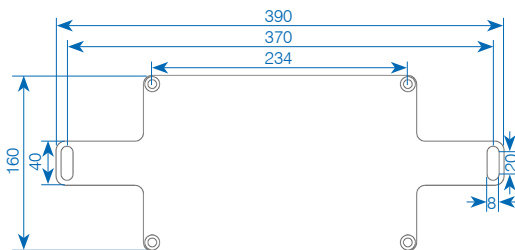

Mounting plate, vertical, V4A stainless steel for boxes type 2516 Item no.: 205559

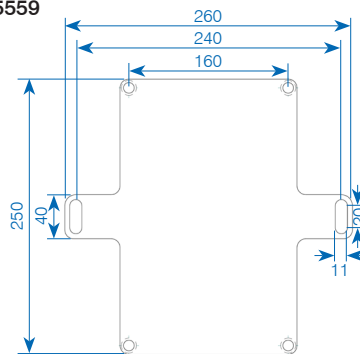

Mounting plate, crosswise, V4A stainless steel for boxes type 3018 Item no.: 189869

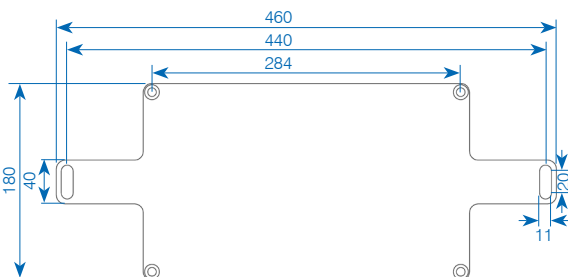

Mounting bracket, V4A stainless steel for boxes type 3018 Item no.: 206819

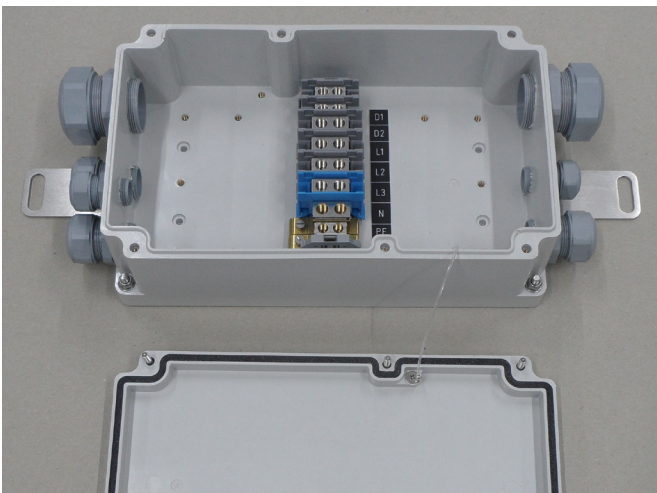
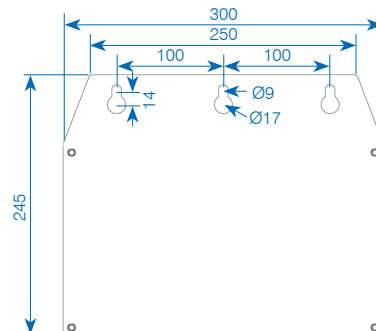

Junction box type 3018 in FE05 with through-wiring DALI

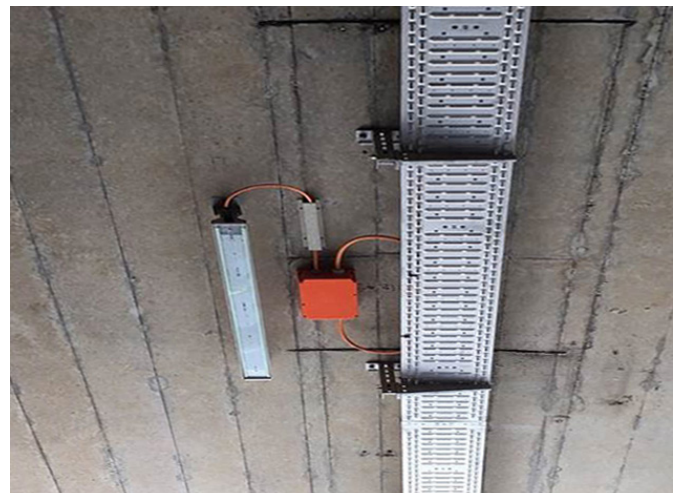

Typical example of an installation with adaptive lighting for emergency power system in FE180/E30

DECONTACTOR™ DS F400

Fireproof plug-in device for fans

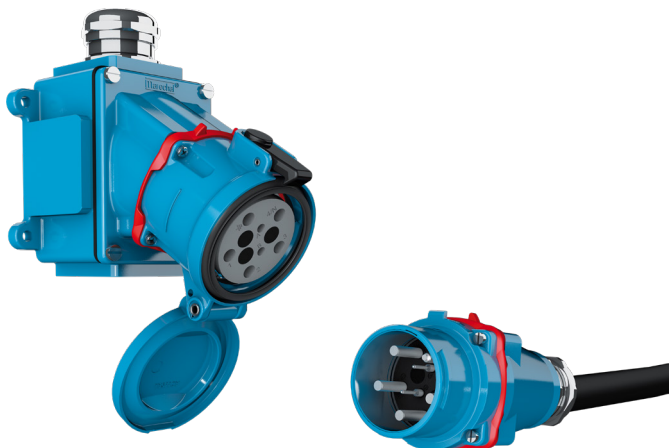

Plug-in device with front pressure contacts and integrated switching function in accordance with IEC/EN 60309-1 and IEC/EN 60309-4 up to 125A and a rated voltage of 690VAC. Disconnecting under load by pushing the button in accordance with AC22 and AC23. The plug and socket unit has IP66/IP67 protection automatically when plugged in. A rotating safety disc increases protection against contact with live parts. The metal housing is highly resistant to chemical and mechanical loads (IK09) and UV radiation.

Technical data

Material:	Metal
Tested according to:	DIN EN 12101-3 tested
Protection category:	IP66/IP67
Impact resistance:	IK09
Temperature range:	-40°C to +60°C

Item no.	Description
254467	Flush-mounted socket DS F400 125A 400V 3L+PE
254470	Wall plinth 30° with thread M32 (without cable gland)
254469	Wall plinth 30° with thread M40 (without cable gland)
254468	Wall plinth 30° with thread M50 (without cable gland)
222117	Cable gland M32 (16-24 mm)
222118	Cable gland M40 (22-32mm)
254734	Cable gland M50 (34-44 mm)
254997	Flush-mounted plug DS F400 125A 400V 3L+PE
254998	Straight handle with thread M32 (without cable gland)
254999	Straight handle with thread M40 (without cable gland)
255000	Straight handle with thread M50 (without cable gland)

The DS F400 plug-in devices facilitate customisation:

- of electrical machines
 - to the European Machinery Directive N° 2006/42/CE regarding the disconnecting device
 - and to EN 60204-1 standard: Safety
 - to the standard EN ISO 14118: Safety
 - avoiding unexpected start-up
- of smoke and heat exhaust ventilators according to standard EN 12101-3 (400°C/2h)

The DS F400 plug connections comply with:

- the European Low Voltage Directive 2014/35/EC (with CE marking) and the RoHS Directive
- the European REACH Regulation 1907/2006/EC
- the breaking capacity standard IEC/EN 60947-3/AC-22 and AC-23

Mounting socket with plug

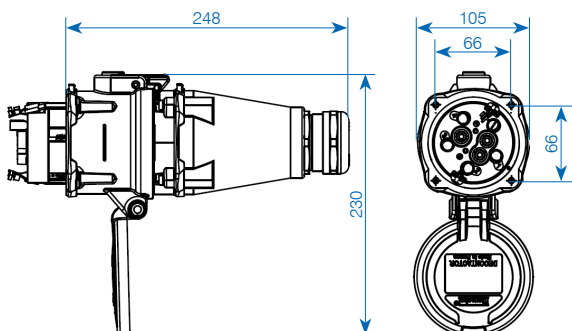

Surface mounted socket with plug

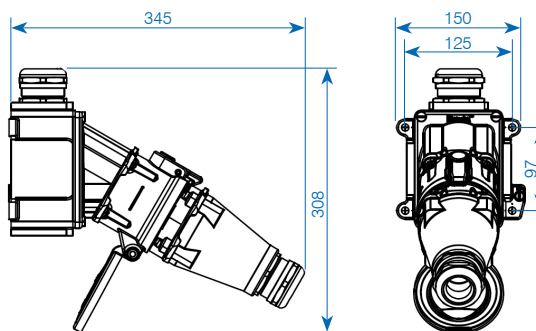

HT 3625 Product Overview

The European standard DIN EN 12101 part 3 stipulates product characteristics for power-operated works smoke and heat exhaust ventilators that are installed in construction works as part of a mechanical smoke and heat exhaust ventilation system.



- Specially developed for motor-driven smoke and heat suction fans
- Proof of function duration at 400° C during 120 min
- Meets all ASTRA regulations in full
- Tested and certified special connector system
- Pluggable tunnel ventilation = greatly facilitates maintenance and repair work
- Entire socket made of rust-free V4A

Technical Data

Material:	Stainless steel 1.4571 (316 Ti)
Testing:	DIN EN 12101-3 tested by MPA Dresden
Internal wiring:	in accordance with customer requirement
Cable entries:	with a range of sizes depending on the project Cable screw fittings available with or without plug connector
Wall mounting:	Hanging brackets V4A
External dimensions:	400×250×150 mm
Protection category:	IP66/IP69
Impact resistance:	IK10

HT 3625 – 400×250×150 mm

System diagram Execution with Maréchal-socket DS F400* (IP66/67)

Item no.: 231165

* not compatible with DS6 series

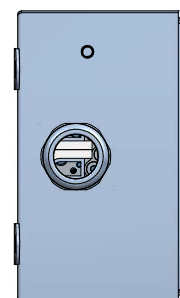
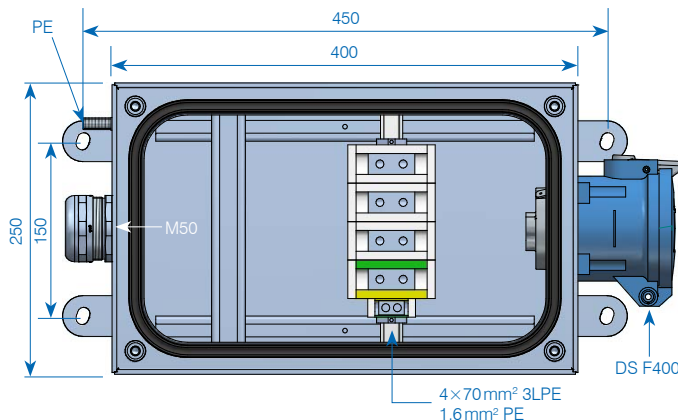
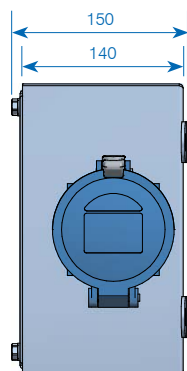
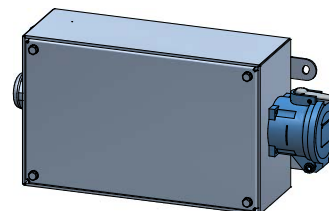

Other versions on request.

GET IN TOUCH WITH US

News about the assortment and specific solutions can be found on our website:

www.gifas.ch

We reserve the right to make technical modifications. V 0724

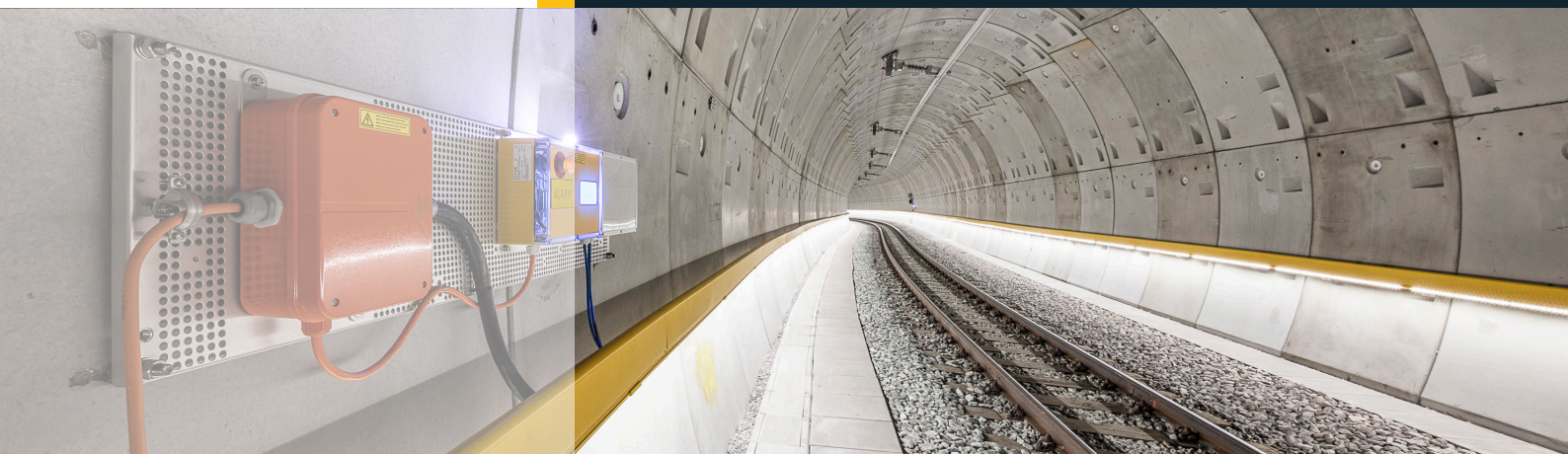

GIFAS
ELECTRIC

GIFAS-ELECTRIC GmbH
Dietrichstrasse 2
CH-9424 Rheineck

+41 71 886 44 44
+41 71 886 44 49
info@gifas.ch
www.gifas.ch