



## Cable crossover SMART for cable max. Ø 30 mm



### General

For many years, has a range of GIFAS cable bridges in the offer. This range was in this period expanded and improved to such new needs of the buyer's marked needs. Today, cable bridges meet the highest standards and have become accepted as the standard for big gatherings and events. Other applications include installations in industrial applications, and mobile sectors, construction companies and emergency services.

### Highest quality

All GIFAS cable bridges are made of polyurethane in the fire protection class B2 (according to DIN 4102) and thus oil, acids, and gasoline resistant. The operating range is  $-40^{\circ}\text{C}$  to  $+70^{\circ}\text{C}$ . The Shore hardness is  $88 \pm 4\text{A}$ . GIFAS cable bridges in accordance with EN 61537:2007; (IEC 61537:2006) in accordance with the provisions of Directive 73/23/EEC (Low Voltage Equipment).

### Customer printing

The cable bridges from 30 pcs. be printed with your company name/logo (as per your instructions).

### Product features

The smallest of the big. Easily and universally applicable. The cable bridge SMART fulfils all expectations of a professional cable protection and extends the range GIFAS a compact, very lightweight (only 5kg), but passable cable bridge in the familiar black/yellow design.

### Technical Data

Material lower section:	polyurethane, black
Material lid black:	polyurethane, yellow
max. load:	app. 2'000 kg/400 cm <sup>2</sup>
Length:	1'000 mm
Width:	290 mm
Height:	48 mm
Channels:	3 channels
Weight:	5 kg

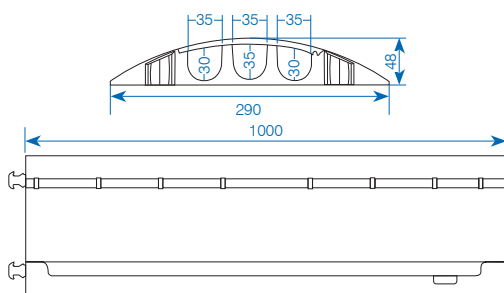

Item no.	Designation
✓ 032295	Cable crossover SMART 3 channels, 290×48×1'000 mm (W×H×D)
✓ 109667	End ramp with groove
✓ 109668	End ramp with plug

✓ from stock, offer subject to prior sale

### Cable crossover MIDI for cable max. Ø 34 mm



#### Product features

The MIDI cable bridge was designed as a solution to the cable bridge between applications and the type COMPACT STANDARD. 5 channels, a lower height and lighter weight molded connectors, and features of this cable bridge.

#### Technical Data

Material lower section: polyurethane, black  
 Material lid black: polyurethane, yellow  
 max. load: app. 2'000 kg / 400 cm<sup>2</sup>  
 Length: 890 mm  
 Width: 542 mm  
 Height: 52 mm  
 Channels: 5 channels  
 Weight: 12 kg

Item no.	Designation
✓ 016031	Cable crossover MIDI 5 channels, 542×52×890 mm (W×H×D)
✓ 020840	Curve 45° for MIDI (incl. 1 pair connecting pin)
020841	End ramp for MIDI

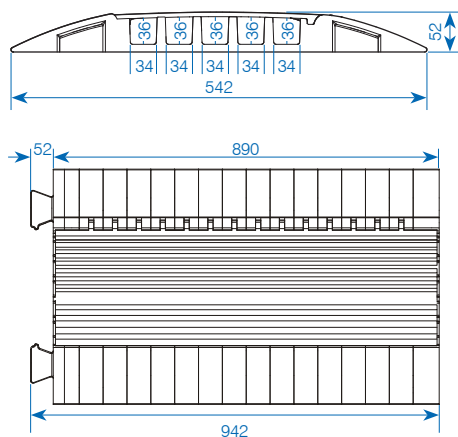

### Cable crossover DEFENDER 3 2D modular, wheelchair accessible

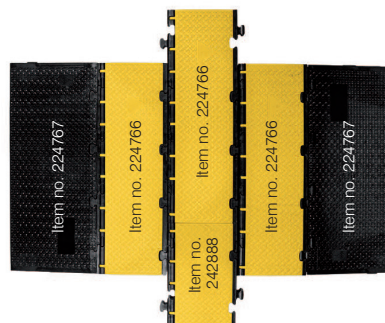

#### Product features

- patented self-cleaning hinges
- fire protection class E according to DIN EN 13501-1
- very stable, tear-resistant and 100% recyclable plastic
- resistant to oil, petrol and short-term contact with solvents
- hardness range 88 Shore-A ± 4
- high-strength all-round cable crossover with 3D laser grip anti-slip surface of black, recycled polyurethane
- yellow recyclable polyurethane cover with high warning effect
- simple, multi-directional modular design with unlimited width and length expandability

#### Technical data

Material lower section: polyurethane, black  
 Material lid black: polyurethane, yellow  
 max. load: approx. 5'000 kg / 750 cm<sup>2</sup>  
 Dimensions (l×w×h):  
 - Item no. 224766: 1'000×330×73 mm  
 - Item no. 242888: 500×330×73 mm  
 - Item no. 224767: 1'000×600×71 mm  
 Channels: 3 Channels  
 Cuct height (H×B): 2×: 52×49 mm / 1×: 45×50 mm  
 Weight:  
 - Item no. 224766: 13.5 kg  
 - Item no. 242888: 6.75 kg  
 - Item no. 224767: 15.9 kg

Item no.	Designation
✓ 224766	Cable crossover Defender 3 2D, 3 channels modular system, middle part, 1'000×330×73 mm
✓ 242888	Cable crossover Defender 3 2D, 3 channels modular system, middle part, 500×330×73 mm
✓ 224767	Ramp for cable crossover Defender 3 2D modular system, 1'000×600×71 mm

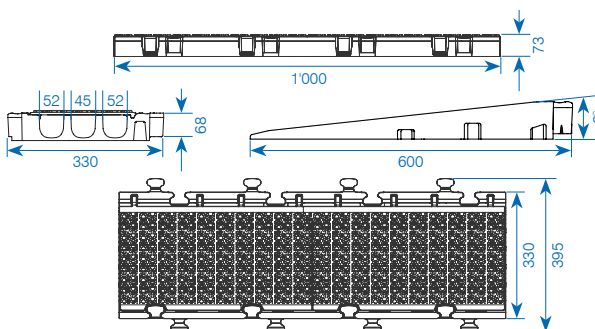

✓ from stock, offer subject to prior sale

**Cable crossover STANDARD**  
for cable max. Ø 49 mm

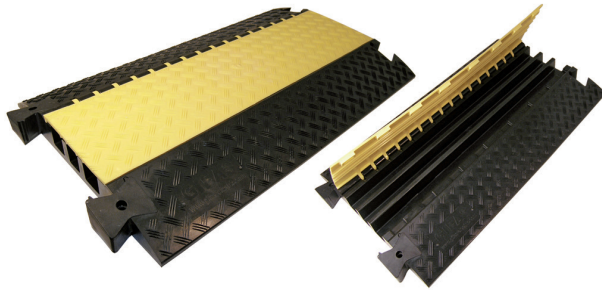

**Product features**

The cable bridge STANDARD, made of black polyurethane with textured anti-slip surface and a striking yellow polyethylene cover combines three cable channels. The cable bridge can connect to each other by means of pins available separately. Each of the cable bridge is already supplied with a pair of connecting pins mounted. The lid with a patented hinge will only be open at the cable entry. The integrated zipper technology combines improved protection against dirt and/or tearing as opposed to conventional systems Velcro. A complete range of accessories extends the type STANDARD in a flexible system for protection of expensive cables and multi core.

**Technical Data**

Material lower section: polyurethane, black  
 Material lid black: polyurethane, yellow  
 max. load: app. 5'000 kg/400 cm<sup>2</sup>  
 Length: 1'000 mm  
 Width: 600 mm  
 Height: 73 mm  
 Channels: 3 channels  
 Weight: 22 kg

Item no.	Designation
✓ 059553	Cable crossover STANDARD, 3 channels, 600×73×1'000 mm (W×H×D)
✓ 059554	End ramp for STANDARD
✓ 018359	Curve 45° for STANDARD (incl. 1 pair connecting pin)
✓ 059556	Connecting pin for STANDARD

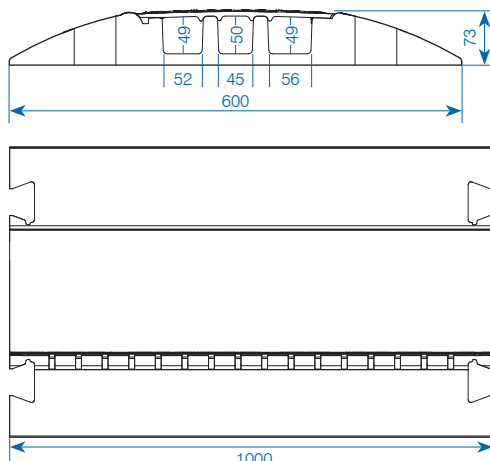

✓ from stock, offer subject to prior sale

**Cable crossover MAXI**  
for cable max. Ø 62 mm

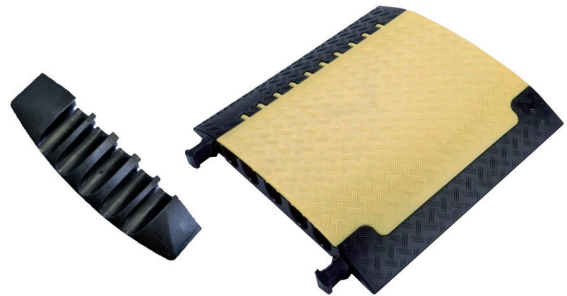

**Product features**

From suggestions from industry and large companies hire the flagship series of cable bridges was developed. 5 oversized cable channels, two of which are suitable for C-types of fire hose (Ø 62 mm). Power cables also find an optimal protection.

**Technical Data**

Material lower section: polyurethane, black  
 Material lid black: polyurethane, yellow  
 max. load: app. 5'000 kg/400 cm<sup>2</sup>  
 Length: 700 mm  
 Width: 696 mm  
 Height: 87 mm  
 Channels: 5 channels  
 Weight: 21.4 kg

Item no.	Designation
✓ 023212	Cable crossover MAXI, 5 channels, 696×87×700 mm (W×H×D)
✓ 023213	End ramp for MAXI

