

ACHTUNG: Diese Zeichnung ist geistiges Eigentum der Firma GIFAS-ELECTRIC und darf daher weder vervielfältigt noch Dritten zugänglich gemacht werden.
 ATTENTION: Ce dessin est propriété de l'entreprise GIFAS-ELECTRIC et ne doit ni être copié ni remis à des tiers.

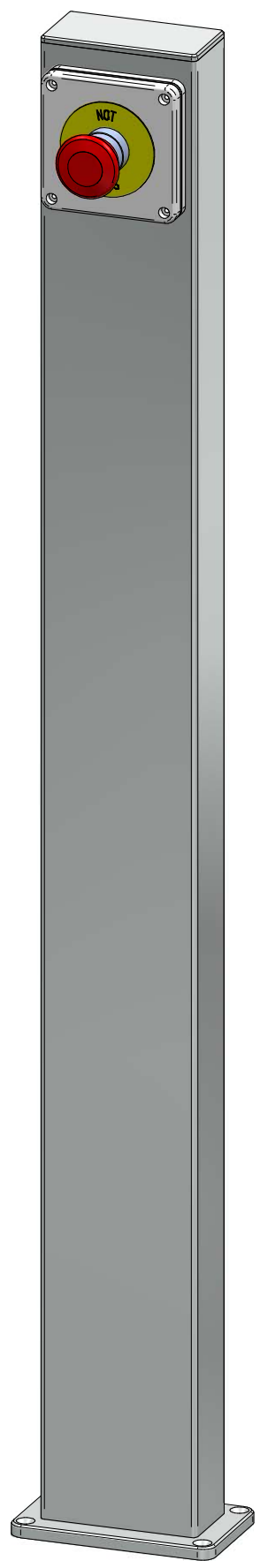

ATTENZIONE: Il presente disegno è di proprietà della ditta GIFAS ELECTRIC. Riproduzione vietata.
 ATTENTION: This design is property of GIFAS-ELECTRIC GmbH and may not be copied or distributed among unauthorized persons.

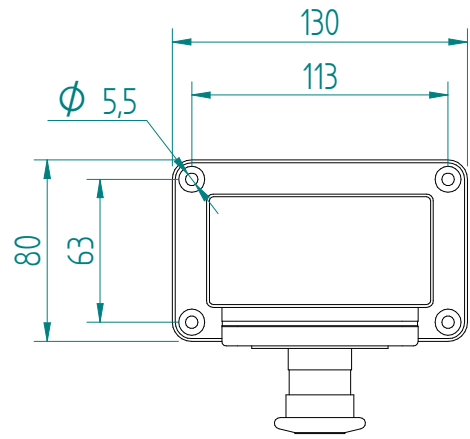
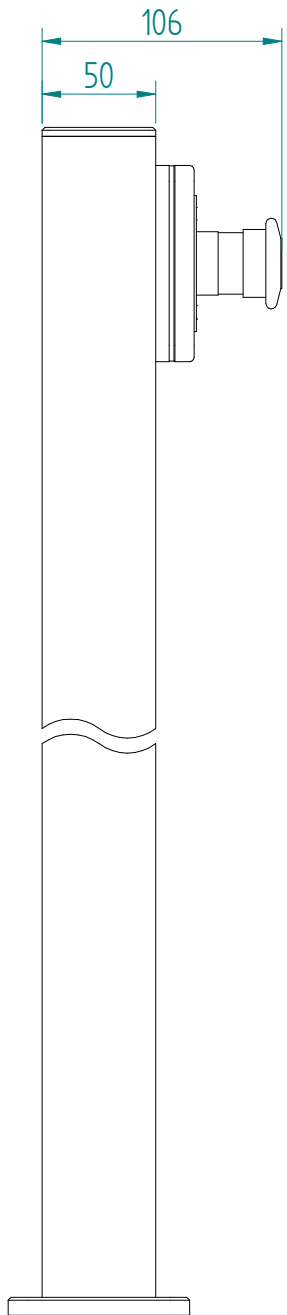
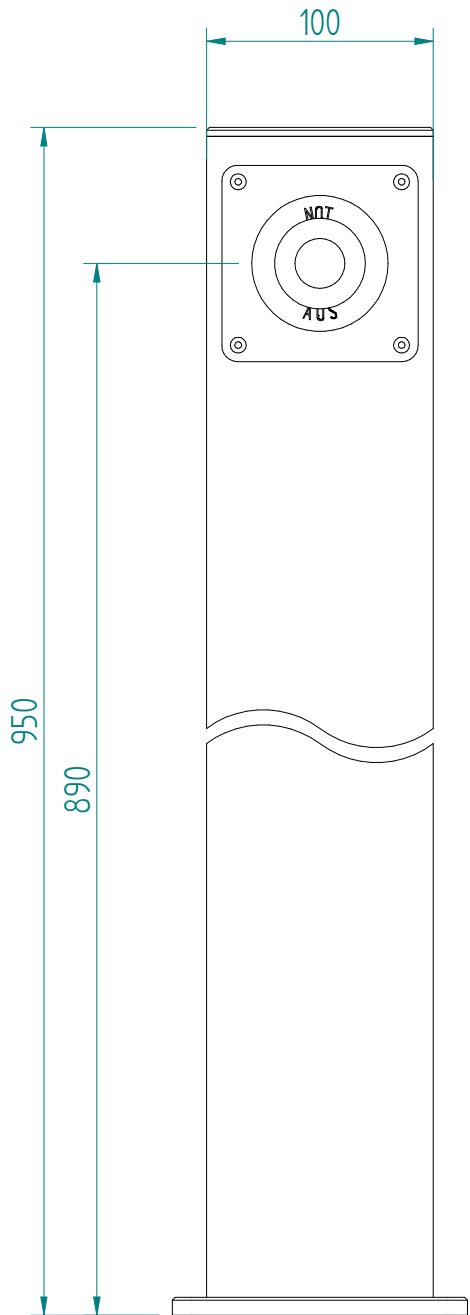

GIFAS-ELECTRIC GmbH
 Dietrichstrasse 2 - CH-9424 Rheineck
 +41 71 886 44 44 info@gifas.ch
 +41 71 886 44 44 www.gifas.ch

Energiesäule
ES-100

Art.-Nr. : **099489**

22.10.2024

Blatt 1/1
 codr