

ACHTUNG: Diese Zeichnung ist geistiges Eigentum der Firma GIFAS-ELECTRIC und darf daher weder vervielfältigt noch Dritten zugänglich gemacht werden.  
 ATTENTION: Ce dessin est propriété de l'entreprise GIFAS-ELECTRIC et ne doit ni être copié ni remis à des tiers.

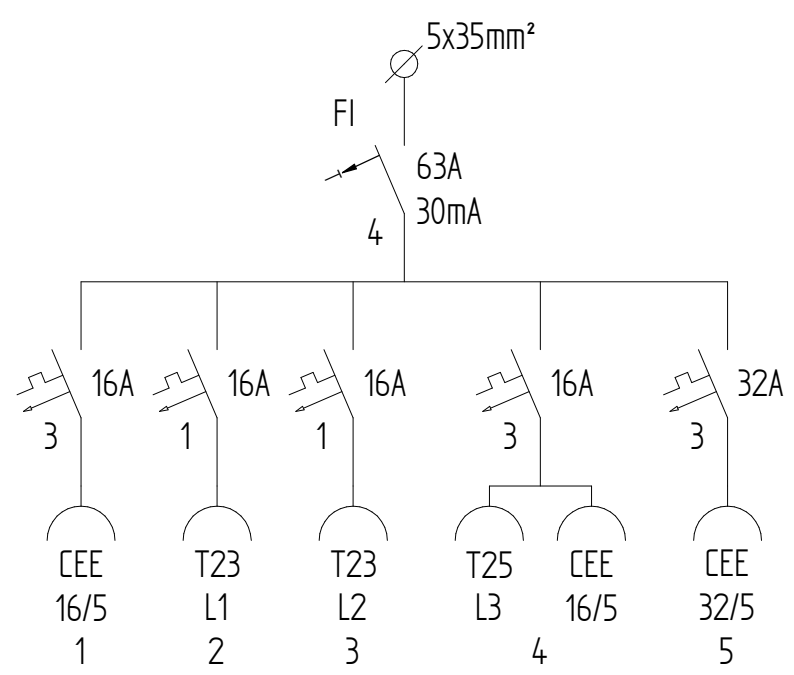

ATTENTION: Il presente disegno è di proprietà della ditta GIFAS ELECTRIC. Riproduzione vietata.  
 ATTENTION: This design is property of GIFAS-ELECTRIC GmbH and may not be copied or distributed among unauthorized persons.

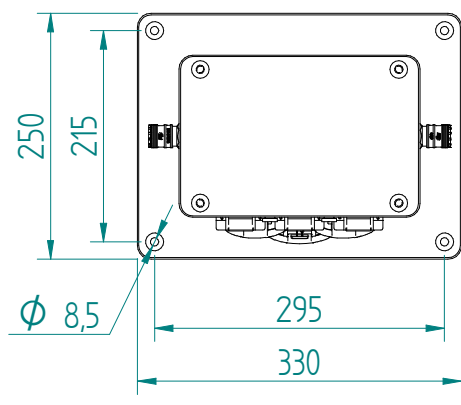
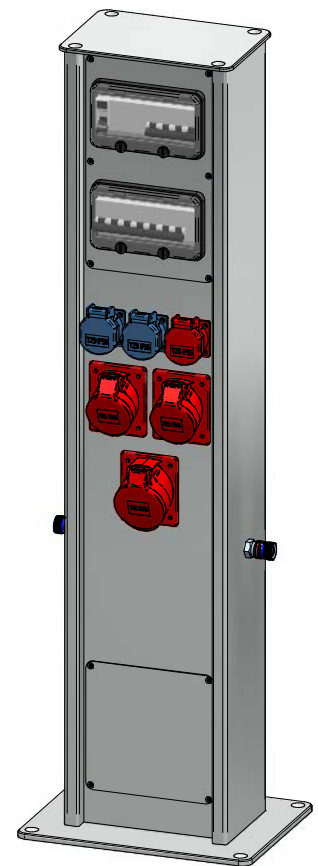
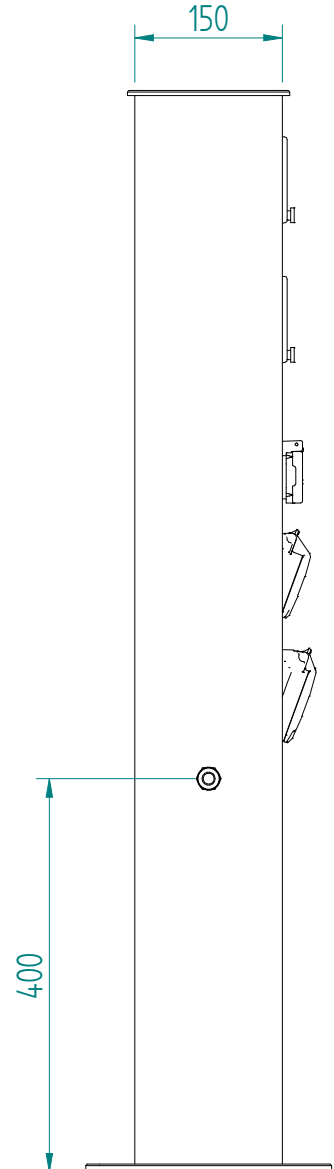
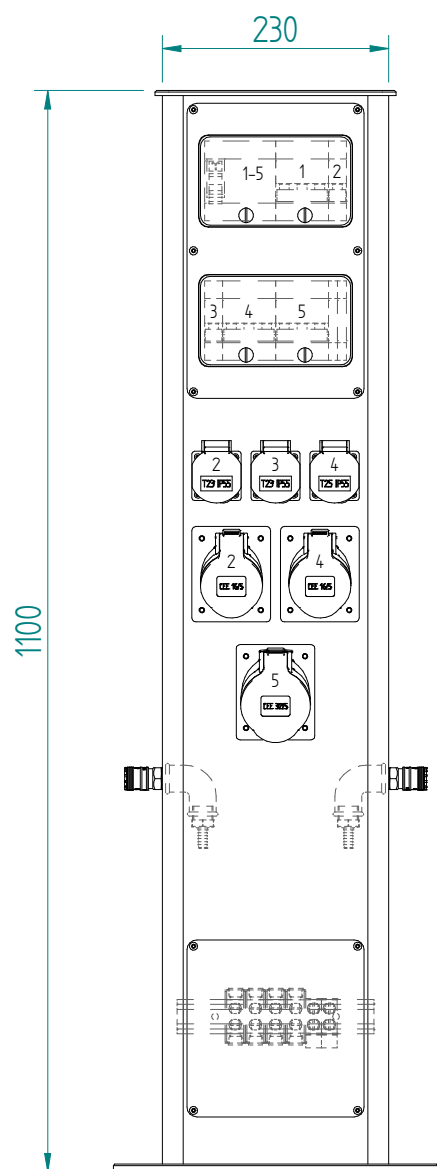

GIFAS-ELECTRIC GmbH  
 Dietrichstrasse 2 - CH-9424 Rheineck  
 +41 71 886 44 44 info@gifas.ch  
 +41 71 886 44 44 www.gifas.ch

**Energiesäule**  
**ES-230**

Art.-Nr. : **228843**

23.10.2024

Blatt 1/1  
 codr