

ACHTUNG: Diese Zeichnung ist geistiges Eigentum der Firma GIFAS-ELECTRIC und darf daher weder vervielfältigt noch Dritten zugänglich gemacht werden.
 ATTENTION: Ce dessin est propriété de l'entreprise GIFAS-ELECTRIC et ne doit ni être copié ni remis à des tiers.

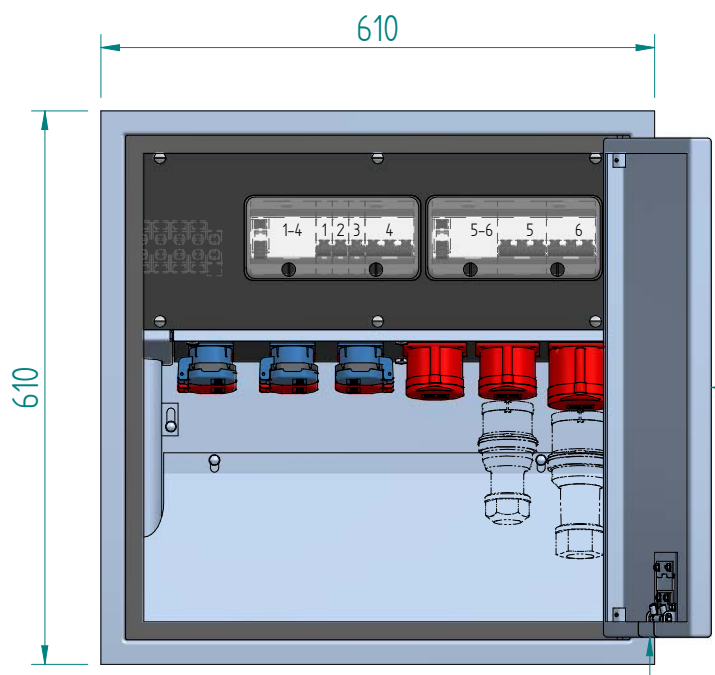

vorbereitet KABA

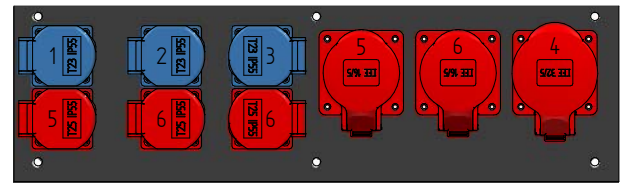
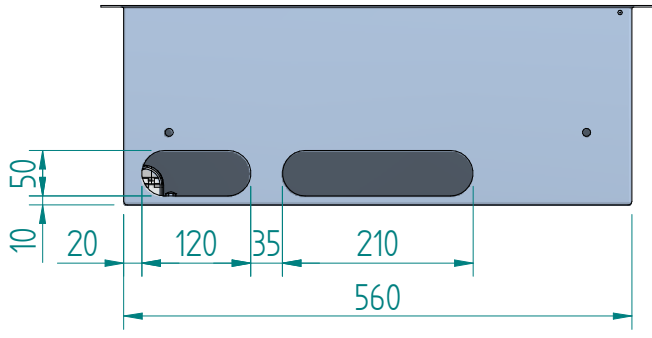
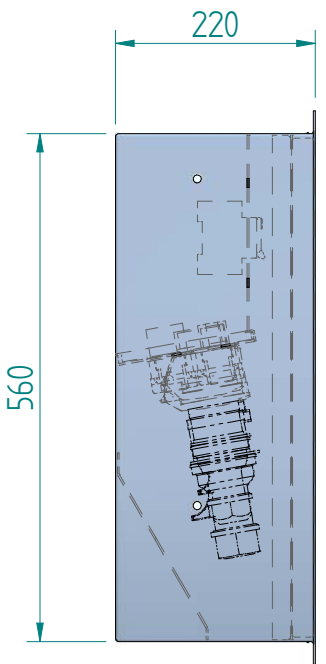

Klappe von innen verriegelbar

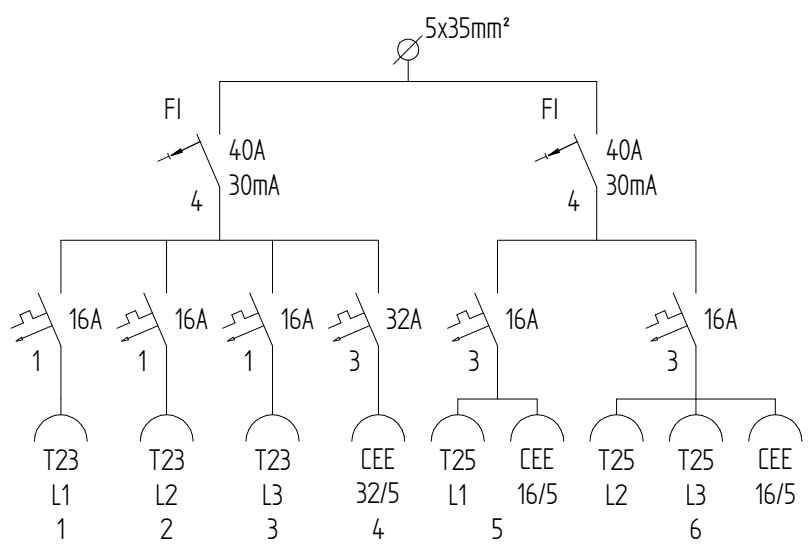
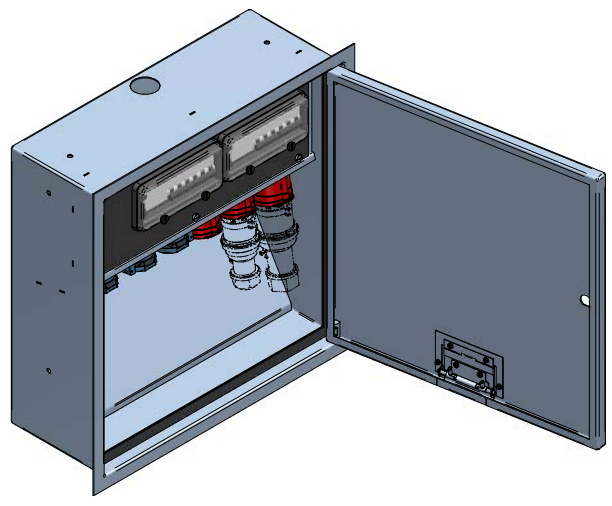
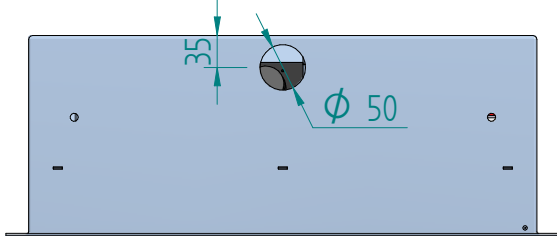

ATTENTION: Il presente disegno è di proprietà della ditta GIFAS ELECTRIC. Riproduzione vietata.
 ATTENTION: This design is property of GIFAS-ELECTRIC GmbH and may not be copied or distributed among unauthorized persons.



GIFAS-ELECTRIC GmbH
 Dietrichstrasse 2 - CH-9424 Rheineck
 +41 71 886 44 44 info@gifas.ch
 +41 71 886 44 44 www.gifas.ch

Unterputz-Stromverteiler
UP-Dose V2A
Typ II 63A

Art.-Nr. : **230136**

06.07.2022

Blatt 1/1
 beku